



A MEMBER OF THE ABB GROUP

Conceptpower DPA
10 – 250 kVA

➤ True modular
UPS system
for critical
applications.

Conceptpower DPA™ S2 Technical Specifications

Conceptpower DPA™ S2 highlights at a glance

- DPA with Safe-Swap Modules (SSM)
For premium power protection availability
- Low total Cost of Ownership (TCO)
Cost saving during entire life-cycle
- Flexibility/Scalability
Ease of power upgrade, pay as you grow
- Enhanced Serviceability
Rapid fault recovery

Safe-Swap Modular Power Protection Power range: 24-200 kW per rack

Specifications are subject to change without notice



TABLE OF CONTENTS

10.1 CONCEPTPOWER DPA SYSTEM DESCRIPTION.....3

10.2 TECHNICAL CHARACTERISTICS.....4

10.2.1 MECHANICAL CHARACTERISTICS MX-FRAMES AND MODULES.....4

10.2.2 POWER SELECTION TABLE CONCEPTPOWER DPA MODULES.....5

10.3 INPUT CHARACTERISTICS.....5

10.3.1 GRAPH: INPUT PF VERSUS % LOAD.....6

10.3.2 GRAPH: INPUT DISTORTION THDI VERSUS % LOAD6

10.4 BATTERY CHARACTERISTICS.....7

10.5 OUTPUT CHARACTERISTICS.....7

10.5.1 GRAPH: AC – AC EFFICIENCY with Linear load @ cosphi 18

10.5.2 GRAPH: Output Power in KW and KVA VERSUS cosphi.....9

10.6 ENVIRONMENTAL CHARACTERISTICS10

10.7 STANDARDS.....10

10.8 COMMUNICATION.....11

10.8.1 POWER MANAGEMENT DISPLAY (PMD).....11

10.8.2 MIMIC DIAGRAM11

10.8.3 DISPLAY.....11

10.8.4 CUSTOMER INTERFACES (Terminals X1...X4).....12

10.8.5 CUSTOMER INPUTS DRY PORT s: Terminal block X112

10.8.6 CUSTOMER OUTPUTS DRY PORTs : Terminal blocks X2, X3, X4.....12

10.9 OPTIONS.....13

10.9.1 SNMP card / WaveMon Management Software.....13

10.9.2 BATTERY CABINETS14

10.10 BATTERY AUTONOMIES.....15

10.10.1 MX Modules: Examples of Internal Battery Autonomy.....15

10.10.2 MX Modules: Examples of External Battery Autonomy.....15

10.11 INSTALLATION PLANNING.....16

10.11.1 HEAT DISSIPATION PER MODULE WITH NON-LINEAR LOAD16

10.12 WIRING AND BLOCK DIAGRAMS FOR ALL FRAMES AND MODULES.....17

10.12.1 TERMINAL CONNECTIONS OVERVIEW17

10.12.2 SINGLE FEED INPUT18

10.12.3 DUAL FEED INPUT.....19

10.1 CONCEPTPOWER DPA™ S2 SYSTEM DESCRIPTION

In environments that demand zero downtime, continuous power protection availability is essential. In order to respond to today's dynamic IT and process-related environments that experience daily change through new server technologies, migration and centralization, resilient and easily adaptable power protection concepts are required.

CONCEPTPOWER DPA™ S2 is the foundation for continuous power protection availability of network-critical infrastructures in enterprise data centers where business continuity has paramount importance and in process control environment where manufacturing continuity is essential.

NEWAVE CONCEPTPOWER DPA™ S2'S is a second generation high-power-density (HPD), leading-edge double-conversion power protection technology that has standardized on a modular component approach which helps speed deployment, improve adaptability and increase system availability while reducing total cost of ownership.

CONCEPTPOWER DPA™ S2'S is a unique on-demand architecture that integrates the power rack, power distribution unit, back-up battery rack and monitoring and management solutions to allow easy selection of optimized configurations.

CONCEPTPOWER DPA™ S2'S (Distributed Parallel Architecture) provides highest availability, unmatched flexibility and at the same time lowest cost of ownership in IT environments.

This Technical Specification provides detailed technical information on the mechanical, electrical and environmental performance of the CONCEPTPOWER DPA™ S2 that can support to give answers to tender and end-user requirements. The CONCEPTPOWER DPA™ S2 was designed to respond to the most stringent safety, EMC and other important UPS standards.

CONCEPTPOWER DPA™ S2 is a rack-mountable modular design. It offers 3-types of Racks (Frames) and 3 types of DPA-Modules to accommodate a wide range of power requirements.



The three MX-Frames; Classic DPA-50, Triple DPA-150, Upgrade DPA-250 can accommodate the three (3) MX-DPA-Modules types DPA 30 or 40 or 50 of: 30kVA/24kW - 40kVA/32kW - 50kVA/40kW power.

Key Features of CONCEPTPOWER DPA S2 Modules:

- | | |
|--|---|
| • Highest Availability
Modular, Decentralized Parallel Architecture (DPA) | <i>Near-zero down time</i> |
| • High Power Density (up to 342kW / m ²),
Small Footprint | <i>Space-saving of expensive floor space</i> |
| • Blade-server-friendly power
Full power from 0.9 lead to 0.8 lag | <i>No de-rating with leading PF loads</i> |
| • Highest Efficiency even with partial loads
Efficiency up to 95.7%
(depending on Module power and type of load) | <i>Energy cost saving during UPS-life-cycle</i> |
| • Very low input current distortion THDi
THDi = < 3 - 4% for loads of 100 – 25 % | <i>Gen-set power and installation cost saving</i> |

10.2 TECHNICAL CHARACTERISTICS

10.2.1 MECHANICAL CHARACTERISTICS MX-FRAMES AND MODULES

CONCEPTPOWER DPA		CLASSIC DPA-50	TRIPLE DPA-150	UPGRADE DPA-250
MX - FRAMES				
Configuration accommodates:	Max.	1 module (30-50kVA) and 280 x 7/9Ah batteries	3 modules (30-50kVA) and 240x 7/9Ah batteries	5 modules (30-50kVA) and no batteries
Max. Power connection	kVA	50	150	250
Dimensions (WxHxD)	mm	730x1650x800	730x1975x800	730x1975x800
Weight of Empty Frame w/o modules and w/o batteries	kg	262	239	205
Weight of Frame with modules and w/o batteries	kg	305 up to 309 (with 1 Module)	368 up to 379 (with 3 Modules)	420 up to 439 (with 5 Modules)
Colours		Front door silver :RAL 9007 + NEWAVE black (inlets) Side walls/top: Graphite grey (Pulverlacke No. 4222903402 serie 09RCCAT1)		

MX- DPA MODULES		DPA 30 S2	DPA 40 S2	DPA 50 S2
Output Apparent Rated Power	KVA	30	40	50
Output Active Rated Power	KW	24	32	40
Output Power with Load PF=1	KVA / KW	24 / 24	32 / 32	40 / 40
Variable Number of 12V Battery Blocks	No.	40-50	40-50	40-50
Dimensions (WxHxD)	mm	663 x 225 x 720		
Weight UPS Module	kg	43.1	45.3	46.8
Colours		Front : Graphite grey (Pulverlacke No. 4222903402 serie 09RCCAT1)		

10.2.2 POWER SELECTION TABLE CONCEPTPOWER DPA MODULES

Concept Power DPA: Power Modules DPA 30 - DPA 50

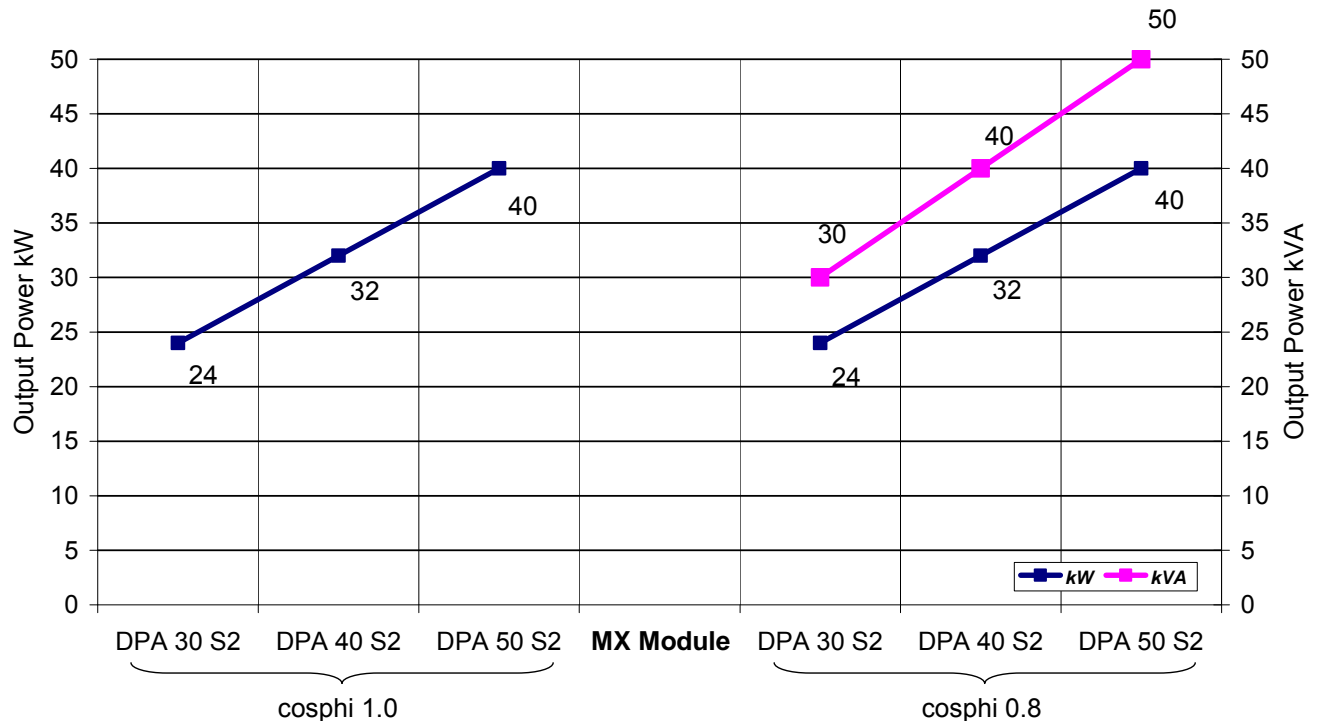

10.3 INPUT CHARACTERISTICS

Module Range		MX		
Module Type		DPA 30 S2	DPA 40 S2	DPA 50 S2
Output Rated Power per Module cosφ 0.8	kVA	30	40	50
Output Rated Power per Module cosφ 1.0	kW	24	32	40
Nominal Input Voltage	V	3x380/220V+N, 3x400V/230V+N, 3x415/240V+N		
Input Voltage Tolerance (ref to 3x400/230V) for Loads in %:	V	(-23%/+15%) 3x308/177 V to 3x460/264 V for < 100 % load (-30%/+15%) 3x280/161 V to 3x460/264 V for < 80 % load (-40%/+15%) 3x240/138 V to 3x460/264 V for < 60 % load		
Input Frequency	Hz	30 - 70		
Input Power Factor		PF=0.99 @ 100 % load		
Inrush Current	A	limited by soft start / max. In		
Input Distortion THDI		Sine-wave THDi = < 3 % @ 100% load		
Max. Input Power with rated output power and charged battery per Module (output Cosφ = 1.0)	kW	25.5	34.0	42.6
Max. Input Current with rated output power and charged battery per Module (output Cosφ = 1.0)	A	36.8	49.1	62.1
Max. Input Power with rated output power and discharged battery per Module (output Cosφ = 1.0)	kW	28.1	37.4	46.8
Max. Input Current with rated output power and discharged battery per Module (output Cosφ = 1.0)	A	40.7	54.2	67.8

10.3.1 GRAPH: INPUT PF VERSUS % LOAD

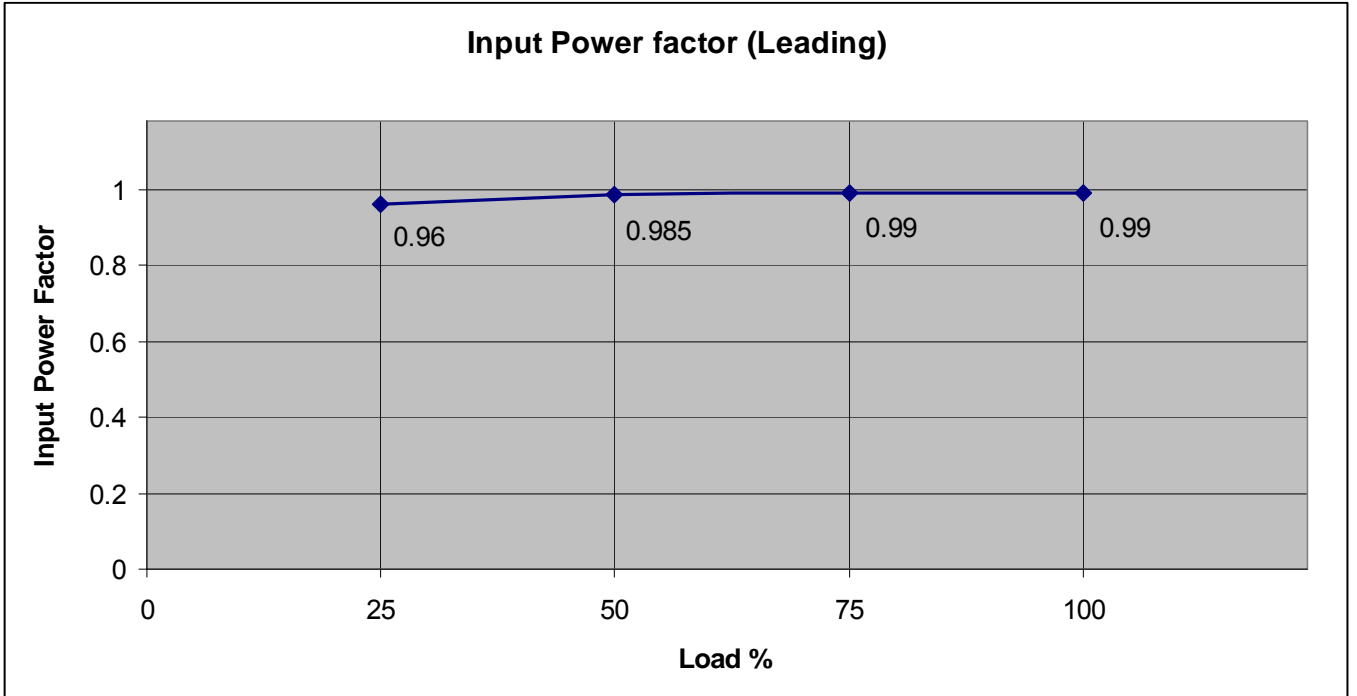

10.3.2 GRAPH: INPUT DISTORTION THDi VERSUS % LOAD

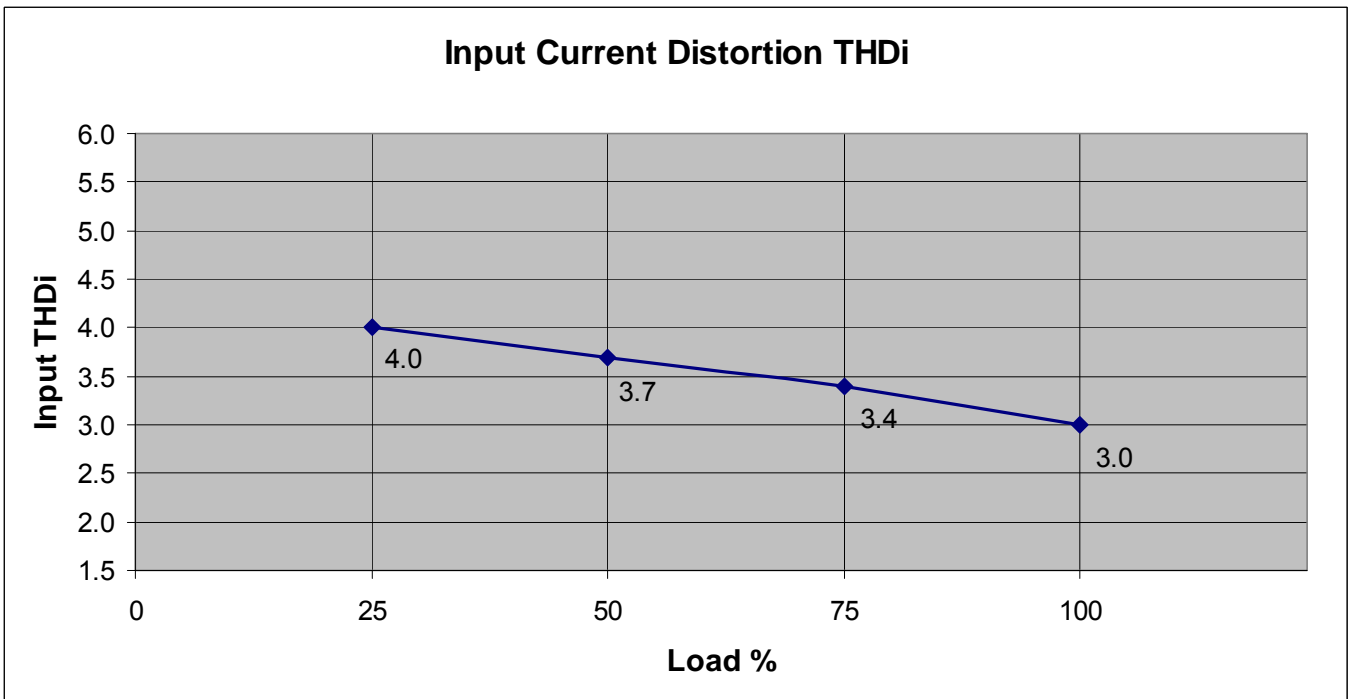

10.4 BATTERY CHARACTERISTICS

Module Range		MX		
Module Type		DPA 30S2	DPA 40 S2	DPA 50 S2
Variable Number of 12V Battery Blocks	No.	40-50	40-50	40-50
Maximum Battery Charger Current	A	10A Standard		
Battery Charging Curve		Ripple free ; IU (DIN 41773)		
Temperature compensation		Standard (temp. sensor optional)		
Battery Test		Automatic and periodically (adjustable)		
Battery Type		Maintenance free VRLA or NiCd		
1) On Inverter mode 50 KVA/40kW on Bypass mode 45 KVA/40kW				

10.5 OUTPUT CHARACTERISTICS

Module Range		MX		
Module Type		DPA 30 S2	DPA 40 S2	DPA 50 S2
Output Rated Power per Module	kVA	30	40	50
Output Rated Power per Module	KW	24	32	40
Output Current In @ cosphi 1.0 (400 V)	A	35	46.5	58
Output Rated Voltage	V	3x380/220V or 3x400/230V or 3x415/240V		
Output Voltage Stability	%	Static:		< ± 1%
		Dynamic (Step load 0%-100% or 100%-0%)		< ± 4%
Output Voltage Distortion	%	With Linear Load		< 2%
		With Non-linear Load (EN62040-3)		< 4%
Output Frequency	Hz	50 Hz or 60 Hz		
Output Frequency Tolerance	%	Synchronized with mains (selectable for bypass operation)		< ± 2 %
		Free running		or < ± 4 %
				± 0.1 %
Bypass operation		At Nominal Input voltage of 3x400 V +/- 15% or 196 V to 264 V ph-N		
Permissible Unbalanced Load (All 3 phases regulated independently)	%	100%		
Phase Angle Tolerance (With 100 % Unbalanced load)	Deg.	± 0 deg.		
Overload Capability on Inverter	%	125 % load		10 min.
		150 % load		60 sec.
Output short capability (RMS)	A	Inverter :	up to 3 x In during	40 ms
		Bypass :	10 x In during	10 ms
Crest - Factor		3 : 1		

10.5.1 GRAPH: AC – AC EFFICIENCY with Linear load @ cosphi 1

Details refer to paragraph 10.6 Environmental Characteristics

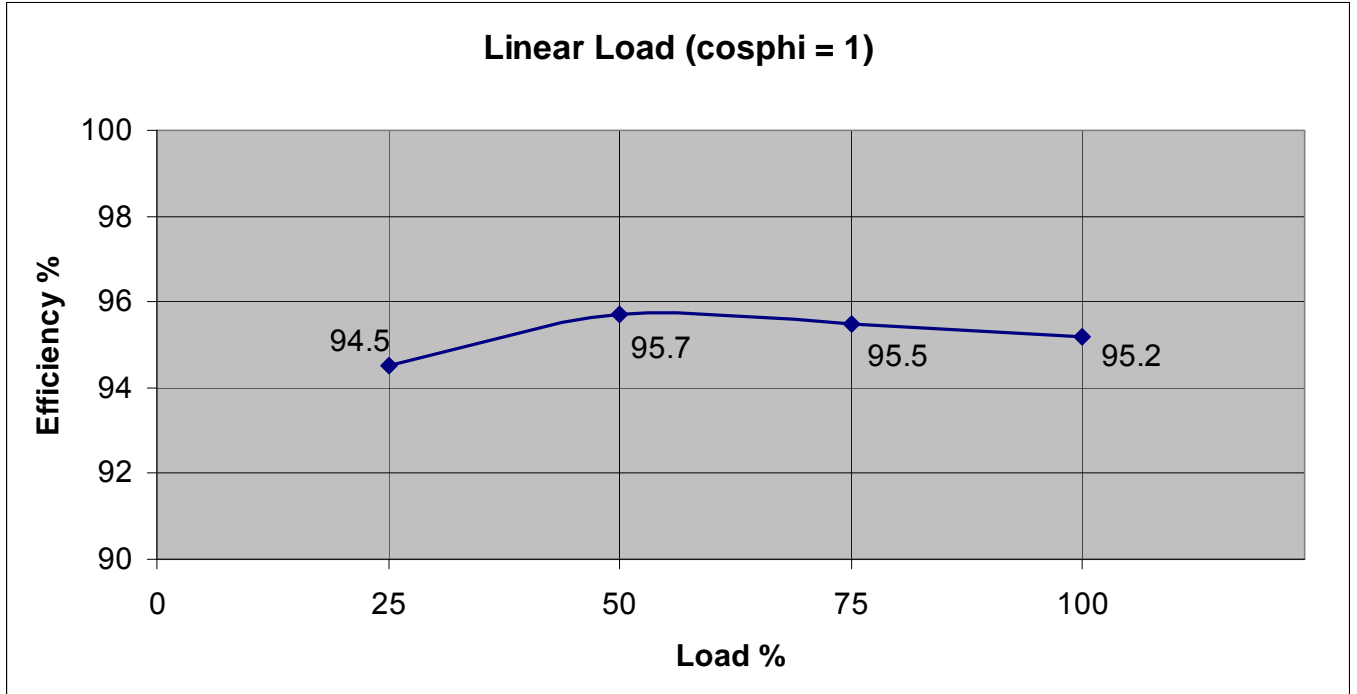

10.5.2 GRAPH: Output Power in KW and KVA VERSUS cosphi

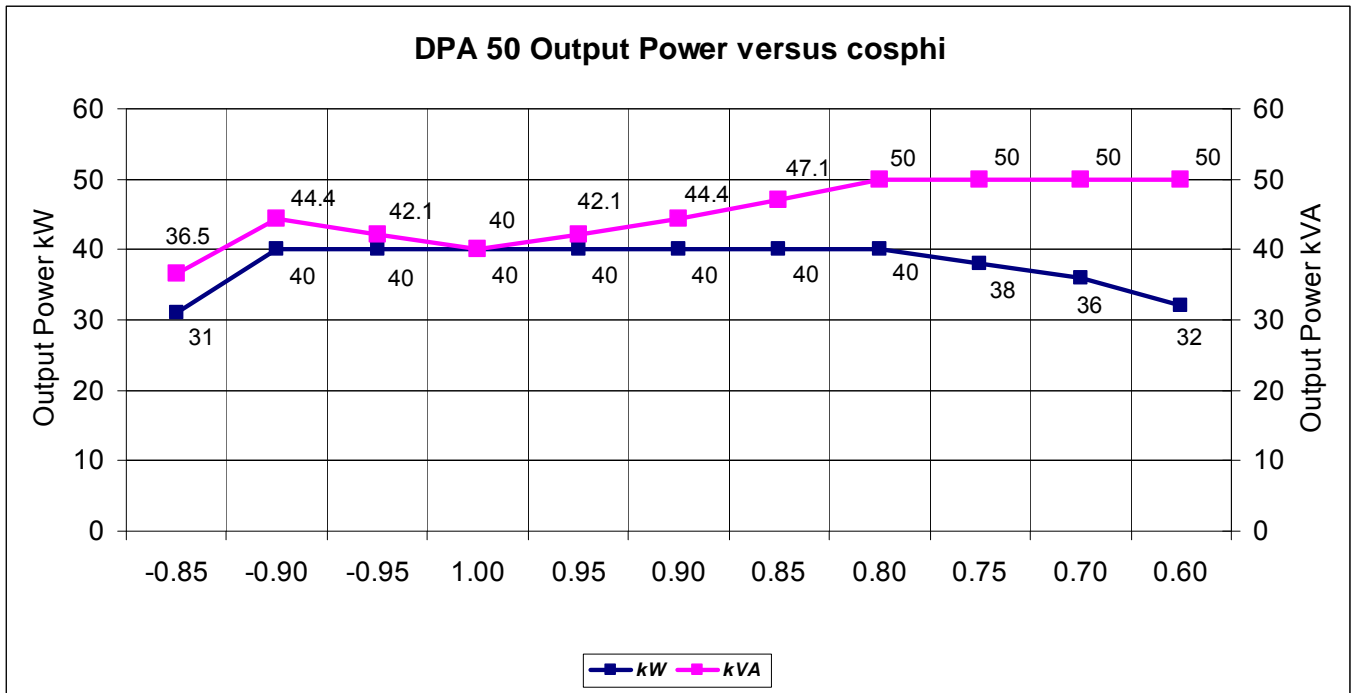

Fig. AC-AC Efficiency of DPA 50 Module

	cosφ	MX Module Range					
		DPA30 S2		DPA40 S2		DPA50 S2	
		kW	kVA	kW	kVA	kW	kVA
Cap.	0.85	18.5	21.8	24.6	29	31	36.5
	0.90	24	26.7	32	35.6	40	44.4
	0.95	24	25.3	32	33.7	40	42.1
	1.00	24	24	32	32	40	40
	0.95	24	25.3	32	33.7	40	42.1
Ind.	0.90	24	26.7	32	35.6	40	44.4
	0.85	24	28.2	32	37.6	40	47.1
	0.80	24	30	32	40	40	50
	0.75	22.9	30	30.5	40	38	50
	0.70	21.7	30	28.9	40	36	50
	0.60	19	30	25.4	40	32	50

Changes of this table without notice – modifications reserved

10.6 ENVIRONMENTAL CHARACTERISTICS

Module Range		MX				
Module Type		DPA 30 S2	DPA 40 S2	DPA 50 S2		
Audible Noise with 100% / 50% Load	dBA	64/55	65/56	65/56		
Operation temperature	°C	0 – 40				
Ambient Temperature for Batteries (recommended)	°C	20 – 25				
Storage Temperature	°C	-25 – +70				
Battery Storage Time at Ambient Temperature		Max. 6 months				
Max. altitude (above sea level)	m	1000m (3300ft) without de-rating				
De-rating factor for use at altitudes above 1000m sea level according (IEC 62040-3)		Meter above sea level (m / ft)		De-Rating Factor for Power		
		1500 / 4850		0.95		
		2000 / 6600		0.91		
		2500 / 8250		0.86		
		3000 / 9900		0.82		
Relative Air-humidity		Max. 95% (non-condensing)				
Accessibility		Totally front accessibility for service and maintenance (no need for side, top or rear access)				
Positioning		Min. 20 cm rear space (required for fan)				
Input and Output Power Cabling		From the bottom on the front				
Efficiency AC-AC up to (at cosphi 1.0) (depending on Module power)	%	Load :	100%	75%	50%	25%
		DPA 30-50:	95.2%	95.5%	95.7%	94.5%
Efficiency Non-linear Load (EN 62040-1-1:2003)		Typically up to 1 % lower of above values				
Eco-Mode efficiency at 100% load	%	98%				

10.7 STANDARDS

Safety	Product Standards IEC/EN 62040-1		Standards IEC/EN 60950-1		
Electromagnetic Compatibility	Product Standards IEC/EN 62040-2		Standards IEC/EN 61000-6-2 ; IEC/EN 61000-6-4 IEC/EN 61000-4-2 ; IEC/EN 61000-4-3 IEC/EN 61000-4-4 ; IEC/EN 61000-4-5 IEC/EN 61000-4-6		
EMC Classification	DPA-30	DPA-40	DPA-50		
Emission Class	C2	C2	C2		
Immunity Class	C3	C3	C3		
Performance	IEC/EN 62040-3				
Product certification	CE				
Degree of protection	IP 20				

10.8 COMMUNICATION

Power Management Display (PMD)	1 LCD display for each module
Serial ports RS232 on Sub-D9	2x system frame + 1x on each module (Smart Port) For monitoring and integration in network management
USB	1x For monitoring and software management
Customer Interfaces : Inputs DRY PORT X1	1 Remote Shut down [EMERGENCY OFF (Normally closed)] 1 GEN-ON (Normally open) 2 Programmable Customer's Inputs (Normally open) 1 Temp. Sensor for Battery Control
Customer Interfaces : Outputs DRY PORT X2 , X3, X4	10 voltage free contacts For remote signalling and automatic computer shutdown
Slot for SNMP	SNMP card (optional) For monitoring and integration in network management

10.8.1 POWER MANAGEMENT DISPLAY (PMD)

The user-friendly PMD consists of three parts the MIMIC DIAGRAM, CONTROL KEYS and LCD that provides the necessary monitoring information about the UPS.

10.8.2 MIMIC DIAGRAM

The mimic diagram serves to give the general status of the UPS. The LED-indicators show the power flow status and in the event of mains failure or load transfer from inverter to bypass and vice-versa the corresponding LED-indicators will change colour from green (normal) to red (warning). The LED's LINE 1 (rectifier) and LINE 2 (bypass) indicate the availability of the mains power supply. The LED's INVERTER and BYPASS if green indicate which of the two are supplying power to the critical load. When the LED-indicator BATTERY is lit it means that the battery due to mains failure is supplying the load. The LED-indicator ALARM is a visual indication of any internal or external alarm condition. At the same time the audible alarm will be activated.

10.8.3 DISPLAY

The 2 x 20 character LCD simplifies the communication with the UPS. The menu driven LCD enables the access to the EVENT REGISTER, or to monitor the input and output U, I, f, P, Autonomy Time and other Measurement's, to perform commands like start-up and shut-down of INVERTER or load transfer from INVERTER to BYPASS and vice-versa and finally it serves for the DIAGNOSIS (SERVICE MODE) for adjustments and testing (for more details see the USER MANUAL of Conceptpower DPA™ S2).

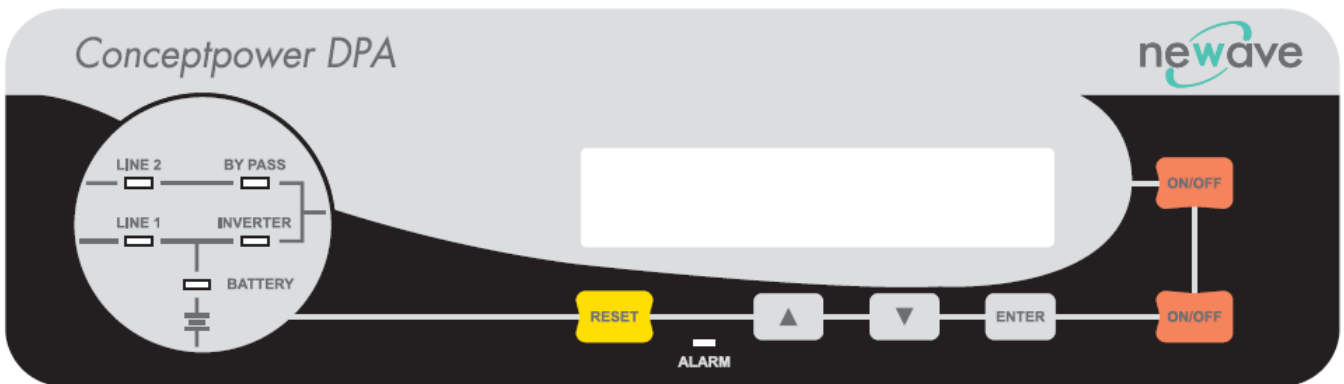

Power Management Display (PMD) of Conceptpower DPM™ S2











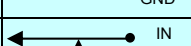

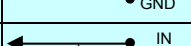



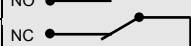

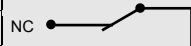
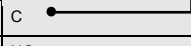
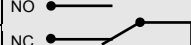
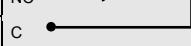

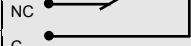

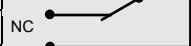

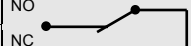
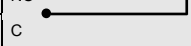

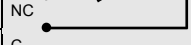
10.8.4 CUSTOMER INTERFACES (Terminals X1...X4)

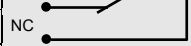
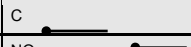
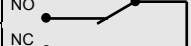
10.8.5 CUSTOMER INPUTS DRY PORT s: Terminal block X1

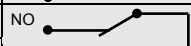
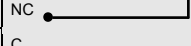
Connection of Remote Shut down facilities, Generator Operation, Customers specials
(see UM Section 9 / OPTIONS)

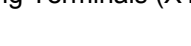
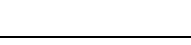
10.8.6 CUSTOMER OUTPUTS DRY PORTs : Terminal blocks X2, X3, X4

Provision of signals for the automatic and orderly shutdown of servers, AS400 or Automation building systems
All voltage free contacts are rated 60 VAC max. and 500 mA max.:
All the interfaces are connected to Phoenix Spring terminals with wires : 0.5 mm2

Block	Terminal	Contact	Signal	On Display	Function
X1	X1 / 1		+ 3.3 Vdc		Remote Shut down
	X1 / 2		GND		(Do not remove the factory mounted bridge until external Remote Shut down is connected)
	X1 / 3		+ 3.3 Vdc		Generator Operation
	X1 / 4		GND		(NC = Generator ON)
	X1 / 5		+ 3.3 Vdc		Customer IN 1
	X1 / 6		GND		(Function on request, to be defined)
	X1 / 7		+ 3.3 Vdc		Customer IN 2
	X1 / 8		GND		(Function on request, to be defined)
	X1 / 9		+ 3.3 Vdc		Temperature Battery
	X1 / 10		GND		(If connected , the battery charger current if depending of the battery temp.)
X2	X2 / 1		ALARM	MAINS_OK	Mains Present
	X2 / 2				Mains Failure
	X2 / 3				Common
	X2 / 4		Message	LOAD_ON_INV	Load on Inverter
	X2 / 5				(Load on Mains bypass)
	X2 / 6				Common
	X2 / 7		ALARM	BATT_LOW	Battery Low
	X2 / 8				Battery OK
	X2 / 9				Common
	X2 / 10		Message	LOAD_ON_MAINS	Load on bypass (Mains)
X3 / 1				(Load on Inverter)	
X3	X3 / 2			Common	
	X3 / 3		ALARM	COMMON_ALARM	Common Alarm (System)
	X3 / 4				NO Alarm Condition
	X3 / 5				Common
	X3 / 6		ALARM	MODUL_ALARM1	Module 1 Alarm
	X3 / 7				NO Alarm Condition
	X3 / 8				Common
	X3 / 9		ALARM	MODUL_ALARM2	Module 2 Alarm
	X3 / 10				NO Alarm Condition
	X4 / 1				Common
X4	X4 / 2		ALARM	MODUL_ALARM3	Module 3 Alarm
	X4 / 3				NO Alarm Condition
	X4 / 4				Common
	X4 / 5		ALARM	MODUL_ALARM4	Module 4 Alarm
	X4 / 6				NO Alarm Condition
	X4 / 7				Common
	X4 / 8		ALARM	MODUL_ALARM5	Module 5 Alarm
	X4 / 9				NO Alarm Condition
	X4 / 10				Common

Phoenix Spring Terminals (X1...X4) Connection

10.9 OPTIONS

- SNMP card and WaveMon Management Software , Modbus Protocol
- External Battery Cabinets
- Parallel bus for additional frames
- In/Output Transformatore for special voltages
- Temp. sensor for battery temp. control

10.9.1 SNMP card / WaveMon Management Software

The Simple Network Management Protocol (SNMP) is a worldwide-standardized communication-protocol. It is used to monitor any device in the network via simple control language. The UPS-Management Software WaveMon also provides its data in this SNMP format with its internal software agent. The operating system you are using must support the SNMP protocol. We offer our WaveMon software with SNMP functionality for Novell, OS/2, all Windows running on INTEL and ALPHA, DEC VMS, Apple.

Two types of SNMP interfaces with identical functionality are available: an external SNMP-Adapter (Box) and an internal SNMP-Card. Both can manage a parallel system (N modules) and return either global values - which are consistent for the whole parallel system - or specific values from the single modules.

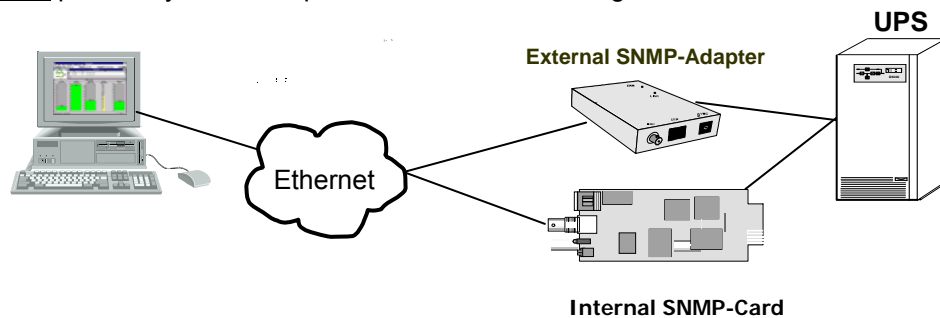

10.9.2 BATTERY CABINETS

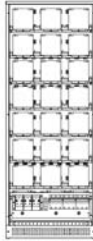
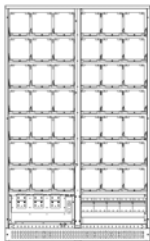
S-type = For Separate. Battery C-type = For Common. Battery		CBAT-DPA-120 S-type or C-type	CBAT-DPA-200 S-type or C-type
BATTERY FRAMES			
Configuration accommodates:	Max.	120 Batt. block x 24Ah/28Ah on 8 shelf 3x5=15 blocks/shelf	200 Batt. blocks x 24Ah/28Ah on 7 shelf 6x5=30 blocks/shelf
Battery fuses / Max. Batt. Strings : Terminals :	S-type	3 / 3 (Terminal 9 x 16/25mm ²)	5 / 5 (Terminal 15 x 16/25mm ²)
Battery fuses / Max. Batt. Strings Terminals :	C-type	3 / 3 + Com. Connection Bar 3 x (2xM8) +PE 2xM8	5 / 5 + Com. Connection Bar 3 x (2xM10) +PE 2xM10
Fuse Type (Very Fast acting)	A	3x100 A	5x100A
Dimensions (WxHxD)	mm	730x1975x800	1200x1975x800
Weight with trays and w/o batteries	kg	290	410
Possible Battery configurations within the Battery Cabinets		Battery Configurations 30x28Ah 40x28Ah 50x28Ah (2x30)x28Ah (2x40)x28Ah (2x50)x28Ah (3x30)x28Ah (3x40)x28Ah	Battery Configurations (2x40)x28Ah (3x40)x28Ah (4x40)x28Ah (5x40)x28Ah (2x50)x28Ah (3x50)x28Ah (4x50)x28Ah (5x30)x28Ah (5x40)x28Ah

10.10 BATTERY AUTONOMIES

10.10.1 MX Modules: Examples of Internal Battery Autonomy

Module Type		DPA 30	DPA 40	DPA 50
Separate Battery configuration		Battery Autonomy in (min.) per Module		
Frame Type	Battery / Module (up to 3 modules / within Triple-150 frame)	30kVA/24KW	40kVA/32KW	50kVA/40KW
CLASSIC DPA-50 or TRIPLE DPA-150	(2x40)x9Ah	8	6	
Common Battery configuration		Battery Autonomy in (min.) for Tot. System Power		
With 1 Module	Module Type	1 x DPA 30	1 x DPA 40	1 x DPA 50
	Total System Power	30kVA/24KW	40kVA/32KW	50kVA/40KW
CLASSIC DPA-50	(2x50)x9Ah	11	8	
CLASSIC DPA-50	(3x40)x9Ah	14	9	
CLASSIC DPA-50	(3x50)x9Ah	18	13	9
CLASSIC DPA-50	(4x50)x9Ah	26	18	14
CLASSIC DPA-50	(5x50)x9Ah	34	24	18
With 2 Modules	Module Type	2 x DPA 30	2 x DPA 40	2 x DPA 50
	Total System Power	60kVA/48KW	80kVA/64KW	100kVA/80KW
TRIPLE DPA-150	2x(2x40)x9Ah	8		
TRIPLE DPA-150	3x(2x40)x9Ah	14	9	7
With 3 Modules	Module Type	3 x DPA 30	3 x DPA 40	3 x DPA 50
	Total System Power	90kVA/72KW	120kVA/96KW	150kVA/120KW
TRIPLE DPA-150	3x(2x40)x9Ah	8	6	

10.10.2 MX Modules: Examples of External Battery Autonomy

This configuration are mostly used in combination with the frame UPGRADE DPA-250

Module Type		DPA 30	DPA 40	DPA 50
Separate Battery configuration		Battery Autonomy in (min.) per Module		
Battery Cabinet (for up to 5 modules linked)	Battery / Module	30kVA/24KW	40kVA/32KW	50kVA/40KW
1x CBAT-DPA-200	40x28Ah	13	9	7
Common Battery configuration		Battery Autonomy in (min.) for Tot. System Power (4+1)		
With 4 Modules	Module Type	4 x DPA 30	4 x DPA 40	4 x DPA 50
	Total System Power	120kVA/96KW	160kVA/128KW	200kVA/160KW
1x CBAT-DPA-120	(3x40)x28Ah	9	6	
1x CBAT-DPA-200	(3x50)x28Ah	12	9	
1x CBAT-DPA-200	(4x50)x28Ah	18	12	9
2x CBAT-DPA-200	5x (2x40) x 28Ah	43	30	22

10.11 INSTALLATION PLANNING

Clearances	X	Y
Minimum	200mm	900 mm

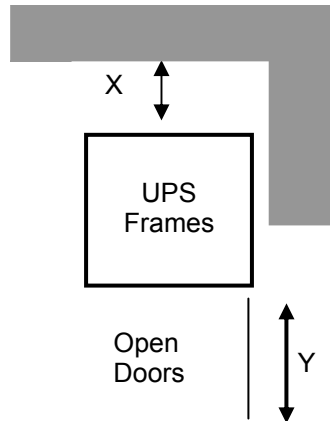

Figure 1: UPS space recommendation

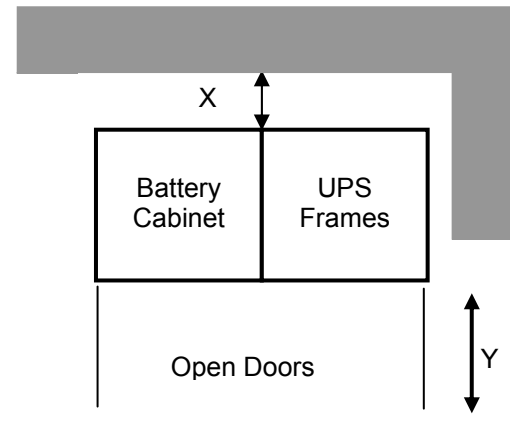

Figure 2 : : UPS + Battery space recommendation

UPS Frame type (50kVA up to 250 kVA)	CLASSIC DPA-50	TRIPLE DPA-150	UPGRADE DPA-250
Dimensions (WxHxD) mm	730x1650x800	730x1975x780	730x1975x800
Battery Cabinet Type	NA	CBAT DPA-120	CBAT DPA-200
Dimensions (WxHxD) mm	NA	730x1975x800	1200x1975x800
Accessibility	Totally front accessibility for service and maintenance (no need for side, top or rear access)		
Positioning	Min. 20 cm rear space (required for fan)		
Input and Output Power Cabling	From the bottom on the front		

10.11.1 HEAT DISSIPATION PER MODULE WITH NON-LINEAR LOAD

Module size		MX		
Module Type		DPA 30 S2	DPA 40 S2	DPA 50 S2
Heat Dissipation with 100% Non-linear Load per Module (EN 62040-1-1:2003)	W	1532	2043	2553
Heat Dissipation with 100% Non-linear Load per Module (EN 62040-1-1:2003)	BTU	5227	6969	8712
Airflow (25° - 30°C) with Non-linear Load per Module (EN 62040-1-1:2003)	m ³ /h	380	380	380

10.12 WIRING AND BLOCK DIAGRAMS FOR ALL FRAMES AND MODULES

The customer has to supply the wiring to connect the UPS to the local power source. The installation inspection and initial start up of the UPS and extra battery cabinet must be carried out by a qualified service personnel such as a licensed service engineer from the manufacturer or from an agent authorised by the manufacturer. More details and procedure are mentioned in the user manual.

10.12.1 TERMINAL CONNECTIONS OVERVIEW

FRAME TYPE Terminals (T) Connection Bar (B)	Separate. Battery (+ / N / -) +PE	Common Battery (+ / N / -) +PE	Input Bypass 3+N	Input Rectifier 3+N+PE	Output load 3+N+PE
CLASSIC DPA-50	3+1 x 16/25mm ² (T)	3+1 x 16/25mm ² (T)	4 x 16/25mm ² (T)	5 x 16/25mm ² (T)	5 x 16/25mm ² (T)
TRIPLE DPA-150	9+1 x 16/25mm ² (T) +PE 1xM10 (B)	3 x M10 (B) +PE 1xM10 (B)	3 x M10(B) +PE 1xM10 (B)	4 x M10 (B) +PE 1xM10 (B)	4 x M10 (B) +PE 1xM10 (B)
UPGRADE DPA-250	15 x 16/25mm ² (T) +PE 1xM12 (B)	3 x M12 (B) +PE 1xM12 (B)	3 x M12 (B) +PE 1xM12 (B)	4 x M12 (B) +PE 1xM12 (B)	4 x M12 (B) +PE 1xM12 (B)

CLASSIC DPA-50

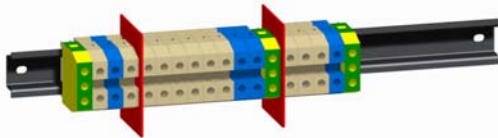

TRIPLE DPA-150



UPGRADE DPA-250

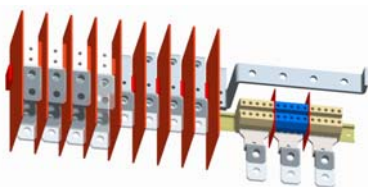

Dual feed input

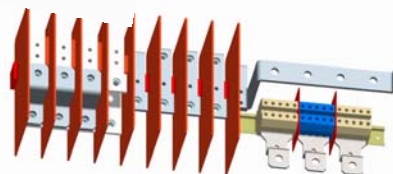

Single feed input

10.12.2 SINGLE FEED INPUT

Cable Sections and Fuse Ratings recommended. Alternatively, local standards to be respected

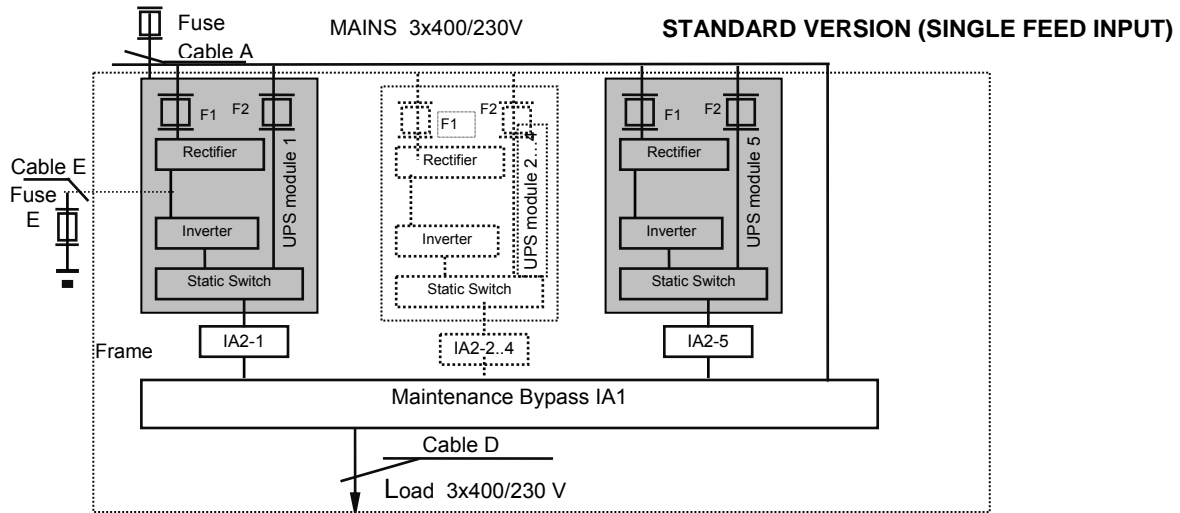

Frame type	Load kVA cosphi 0.8	Input 3x400V			Output 3x400V cosphi 0.8			Battery	
		Fuse A (Agl/CB)	Cable A (mm ²) (IEC 60950-1)	Max. Input Current with battery charging (A)	Cable D (mm ²) (IEC 60950-1)	I _{nom} (A)	Fuse E + / N / - (Agl/CB)	Cable E (mm ²) for CBAT DPA 120 or 200 ONLY + / N / -	
								Com. Battery	Sep. Battery
MX Frames (Frames shall be cabled to there full rating capability)									
CLASSIC DPA 50	50	3x100A	5x25	67	5x25	72 A	3x100A*1	3x25	3x25
TRIPLE DPA-150	150	3x250A	5x120 or 5x(2x50)	202	5x120 or 5x(2x50)	218 A	3x300A*1	3x150	3x (3x25)
UPGRADE DPA-250	250	3x400A	5x(2x95)	337	5x(2x95)	362 A	3x500A*1	3x(2x150)	5x (3x25)
Other intermediate Ratings (we recommend to cable the frame mentioned above at full rating to able future upgrading)									
	30	3x63A	5x10	40	5x10	43 A	3x80A	3x16	
	40	3x80A	5x25	54	5x25	58 A	3x100A*	3x25*	
	45	3x100A	5x25	68	5x25	65 A	3x125A*	3x35*	
	60	3x100A	5x25	81	5x25	87 A	3x125A*	3x35*	
	80	3x125A	5x50	108	5x50	116 A	3x160A*	3x50*	
	90	3x160A	5x50	121	5x50	130 A	3x200A*	3x70*	
	100	3x160A	5x50	135	5x50	145 A	3x224A*	3x95*	
	120	3x200A	5x70	161	5x70	174 A	3x250A*	3x120*	
	160	3x250A	5x120 or 5x(2x50)	215	5x120 or 5x(2x50)	232 A	3x350A*	3x(2x70)*	
	200	3x315A	5x185 or 5x(2x70)	267	5x185 or 5x(2x70)	290 A	3x450A*	3x(2x95)*	

*1 only valid for common battery use

10.12.3 DUAL FEED INPUT

Cable Sections and Fuse Ratings recommended. Alternatively, local standards to be respected

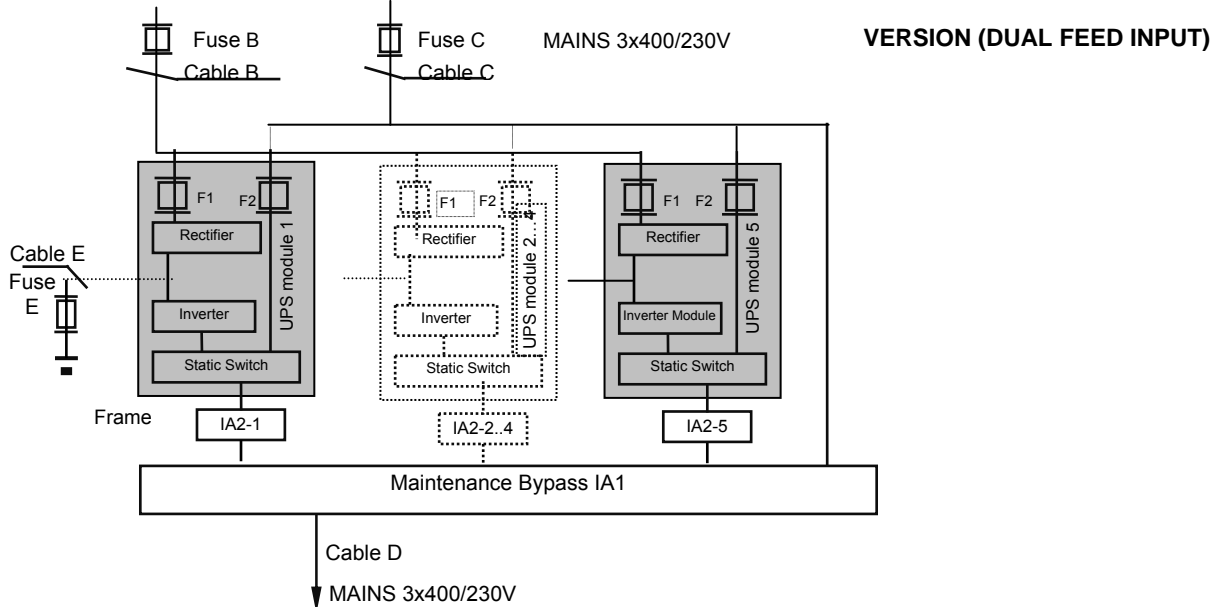

Frame type	Load kVA cosphi 0.8	Input 3x400V			Bypass 3x400V		Output 3x400V cosphi 0.8		Battery		
		Fuse B (Agl/CB)	Cable B (mm ²) (IEC 60950-1)	Max. Input Current with battery charging (A)	Fuse C (Agl/CB)	Cable C (mm ²) (IEC 60950-1)	Cable D (mm ²) (IEC 60950-1)	I nom	Fuse E +/N/- (Agl/CB)	Cable E (mm ²) for CBAT DPA 120 or 200 ONLY + / N / -	
Com. Battery											
Sep. Battery											
MX Frames (Frames shall be cabled to there full rating capability)											
CLASSIC DPA 50	50	3x100A	5x25	67	3x100A	4x25	5x25	72 A	3x100A*1	3x25	3x25
TRIPLE DPA-150	150	3x250A	5x120 or 5x(2x50)	202	3x250A	4x120 or 4x(2x50)	5x120 or 5x(2x50)	218 A	3x300A*1	3x150	3x(3x25)
UPGRADE DPA-250	250	3x400A	5x(2x95)	337	3x400A	4x(2x95)	5x(2x95)	362 A	3x500A*1	3x(2x150)	5x(3x25)
Other intermediate Ratings (we recommend to cable the frame mentioned above at full rating to able future upgrading)											
	30	3x63A	5x10	40	3x63A	4x10	5x10	43 A	3x80A	3x16	
	40	3x80A	5x25	54	3x80A	4x25	5x25	58 A	3x100A*	3x25*	
	45	3x100A	5x25	68	3x100A	4x25	5x25	65 A	3x125A*	3x35*	
	60	3x100A	5x25	81	3x100A	4x25	5x25	87 A	3x125A*	3x35*	
	80	3x125A	5x50	108	3x125A	4x50	5x50	116 A	3x160A*	3x50*	
	90	3x160A	5x50	121	3x160A	4x50	5x50	130 A	3x200A*	3x70*	
	100	3x160A	5x50	135	3x160A	4x50	5x50	145 A	3x224A*	3x95*	
	120	3x200A	5x70	161	3x200A	4x70	5x70	174 A	3x250A*	3x120*	
	160	3x250A	5x120 or 5x(2x50)	215	3x250A	4x120 or 4x(2x50)	5x120 or 5x(2x50)	232 A	3x350A*	3x(2x70)*	
	200	3x315A	5x185 or 5x(2x70)	267	3x315A	4x185 or 4x(2x70)	5x185 or 5x(2x70)	290 A	3x450A*	3x(2x95)*	

*1 only valid for common battery use