



A MEMBER OF THE ABB GROUP

## DPA UPScale ST 10–120 kW

➤ Best-in-class  
modular UPS  
for maximum  
availability.

# DPA UPSCALE™ ST TECHNICAL SPECIFICATIONS

### DPA UPSCALE™ highlights at a glance

- DPA UPScale with Safe-Swap Modules (SSM) *For premium power protection availability*
- Low total Cost of Ownership (TCO) *Cost saving during entire life-cycle*
- Flexibility/Scalability *Ease of power upgrade, pay as you grow*
- Enhanced Serviceability *Rapid fault recovery*

## Safe-Swap Modular Power Protection Power range: 10-120 kW per rack

*Specifications are subject to change without notice*

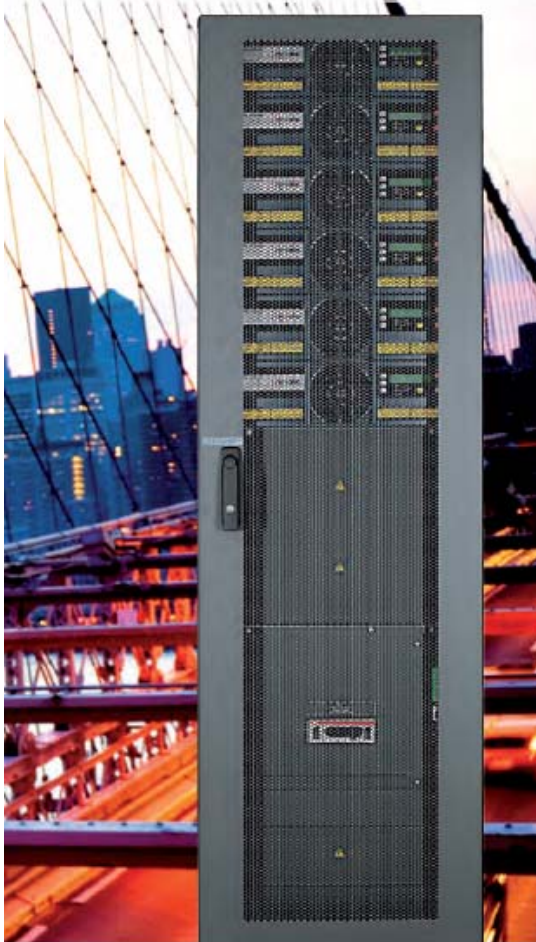

<b>TABLE OF CONTENTS</b>
--------------------------

<b>10.1</b>	<b>DPA UPScale ST SYSTEM DESCRIPTION .....</b>	<b>3</b>
<b>10.2</b>	<b>TECHNICAL CHARACTERISTICS .....</b>	<b>4</b>
10.2.1	MECHANICAL CHARACTERISTICS FRAMES AND MODULES .....	4
<b>10.3</b>	<b>INPUT CHARACTERISTICS .....</b>	<b>5</b>
10.3.1	GRAPH: INPUT PF VERSUS % LOAD.....	6
10.3.2	GRAPH: INPUT DISTORTION THDI VERSUS % LOAD .....	6
<b>10.4</b>	<b>BATTERY CHARACTERISTICS.....</b>	<b>7</b>
<b>10.5</b>	<b>OUTPUT CHARACTERISTICS .....</b>	<b>7</b>
10.5.1	GRAPH: AC – AC EFFICIENCY with Linier load @ cosphi 1 .....	8
10.5.2	GRAPH: Output Power in KW and KVA VERSUS cosphi.....	8
<b>10.6</b>	<b>ENVIRONMENTAL CHARACTERISTICS .....</b>	<b>9</b>
<b>10.7</b>	<b>STANDARDS.....</b>	<b>9</b>
<b>10.8</b>	<b>COMMUNICATION .....</b>	<b>10</b>
10.8.1	POWER MANAGEMENT DISPLAY (PMD).....	10
10.8.2	MIMIC DIAGRAM .....	10
10.8.3	DISPLAY.....	10
10.8.4	CUSTOMER INTERFACES Terminals X1..X2 .....	11
10.8.5	CUSTOMER INPUTS DRY PORT s: Terminal block X2 .....	11
10.8.6	CUSTOMER OUTPUTS DRY PORTs : Terminal blocks X1.....	11
<b>10.9</b>	<b>OPTIONS .....</b>	<b>12</b>
10.9.1	SNMP card / WaveMon Management Software.....	12
10.9.2	BATTERY CABINETS .....	12
<b>10.10</b>	<b>BATTERY AUTONOMIES.....</b>	<b>13</b>
10.10.1	Examples of Internal Battery Autonomy of DPA UPScale ST40 and ST 60 .....	13
10.10.2	Examples of External Battery Autonomy .....	14
<b>10.11</b>	<b>INSTALLATION PLANNING .....</b>	<b>15</b>
10.11.1	HEAT DISSIPATION PER MODULE WITH NON-LINEAR LOAD .....	15
<b>10.12</b>	<b>WIRING AND BLOCK DIAGRAMS FOR ALL FRAMES AND MODULES.....</b>	<b>16</b>
10.12.1	TERMINAL CONNECTIONS OVERVIEW .....	16
10.12.2	SINGLE FEED INPUT .....	17
10.12.3	SINGLE FEED INPUT / Cable Sections.....	17
10.12.4	DUAL FEED INPUT.....	18
10.12.5	Dual FEED INPUT / Cable Sections.....	18

## 10.1 DPA UPScale ST SYSTEM DESCRIPTION

In environments that demand zero downtime, continuous power protection availability is essential. In order to respond to today's dynamic IT and process-related environments that experience daily change through new server technologies, migration and centralization, resilient and easily adaptable power protection concepts are required. DPA UPScale is the foundation for continuous power protection availability of network-critical infrastructures in enterprise data centers where business continuity has paramount importance and in process control environment where manufacturing continuity is essential.

NEWAVE DPA UPScale's is a second generation high-power-density (HPD), leading-edge double-conversion power protection technology that has standardized on a modular component approach which helps speed deployment, improve adaptability and increase system availability while reducing total cost of ownership.

DPA UPScale's is a unique on-demand architecture that integrates the power rack, power distribution unit, back-up battery rack and monitoring and management solutions to allow easy selection of optimized configurations.

DPA UPScale's (Distributed Parallel Architecture) provides highest availability, unmatched flexibility and at the same time lowest cost of ownership in IT environments.

This Technical Specification provides detailed technical information on the mechanical, electrical and environmental performance of the DPA UPScale model types that can support to give answers to tender and end-user requirements. The DPA UPScale family was designed to respond to the most stringent safety, EMC and other important UPS standards. DPA UPScale family is offered in two types of solutions:

**A) DPA UPScale ST** is a rack-mounted modular design offering 4-types of Racks (Frames) types. This solution can accommodate 2 types of DPA UPScale Rack based Modules for a wide range of power requirements:

**DPA UPScale ST** (standard) frames:

- DPA UPScale ST 40 (40kW)
- DPA UPScale ST 60 (60kW)
- DPA UPScale ST 80 (80kW)
- DPA UPScale ST 120 (120kW)

DPA UPScale Modules types:



- UPScale M 10 (kW)
- UPScale M 20 (kW)

### Key Features of DPA UPScale ST:

- |   |   |
|---|---|
| • Highest Availability<br>Modular, Decentralized Parallel Architecture (DPA)  | <i>Near-zero down time</i>                        |
| • High Power Density (up to 272kW / m <sup>2</sup> ),<br>Small Footprint  | <i>Space-saving of expensive floor space</i>      |
| • Unity Output Power Factor<br>Full power for loads with unity PF   | <i>No de-rating for loads with Unity PF</i>       |
| • Highest Efficiency even with partial loads<br>Efficiency = 94.5 - 95.5% for loads 25-100%<br>(depending on Module power and type of load) | <i>Energy cost saving during UPS-life-cycle</i>   |
| • Very low input current distortion THDi<br>THDi = < 3@ 100 % load  | <i>Gen-set power and installation cost saving</i> |

## 10.2 TECHNICAL CHARACTERISTICS

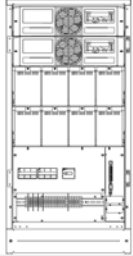
### 10.2.1 MECHANICAL CHARACTERISTICS FRAMES AND MODULES

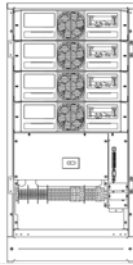
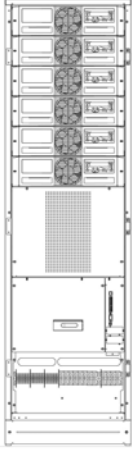
DPA UPScale ST		UPSscale ST 40	UPSscale ST 60	UPSscale ST 80	UPSscale ST 120
DPA UPScale ST FRAMES					
Configuration accommodates:	Max.	2 modules (10 or 20kW) and 80 x 7/9Ah batteries	3 modules (10 or 20kW) and 240 x 7/9Ah batteries	4 modules (10 or 20kW) and NO batteries	6 modules (10 or 20kW) and NO batteries
Max. Power connection	kW	40	60	80	120
Dimensions (WxHxD)	mm	550x1135x770	550x1975x770	550x1135x770	550x1975x770
Weight of Empty Frame w/o modules and w/o batteries	kg	92	173	82	133
Weight of Frame with modules and w/o batteries	kg	130 up to 136 (with 2 Module)	229 up to 238 (with 3 Module)	157 up to 169 (with 4 Modules)	245 up to 263 (with 6 Modules)
Colours		Front : Graphite grey (Pulverlacke No. 4222903402 serie 09RCCAT1) Side walls: Graphite grey (Pulverlacke No. 4222903402 serie 09RCCAT1)			

MODULES		UPSscale M 10	UPSscale M 20
Output Active Rated Power	KW	10	20
Variable Number of 12V Battery Blocks	No.	20-50 *1)	30-50 *1)
Dimensions (WxHxD)	mm	488 x 132 x 540 (3 HU)	
Weight UPS Module	kg	18.6	21.5
Colors		Front : RAL 7016	

Note : \* 1) Depending of the effective load in kW used by the module (see chapter 10.5 Battery characteristics)

**10.3 INPUT CHARACTERISTICS**

Module Range		UPScale M 10 or M 20	
Module Type		UPScale M 10	UPScale M 20
Output Rated Power per Module $\cos\phi$ 0.8	kVA	10	20
Output Rated Power per Module $\cos\phi$ 1.0	KW	10	20
Nominal Input Voltage	V	3x380/220V+N, 3x400V/230V+N, 3x415/240V+N	
Input Voltage Tolerance (ref to 3x400/230V) for Loads in %:	V	(-23%/+15%) 3x308/177 V to 3x460/264 V for <100 % load (-30%/+15%) 3x280/161 V to 3x460/264 V for < 80 % load (-40%/+15%) 3x240/138 V to 3x460/264 V for < 60 % load	
Input Frequency	Hz	35 – 70	
Input Power Factor		PF=0.99 @ 100 % load	
Inrush Current	A	max. In	
Input Distortion THDI		Sine-wave THDi = < 3 % @ 100% load	
Max. Input Power with rated output power and charged battery <b>per Module</b> (output $\cos\phi$ = 1.0)	kW	10.5	21
Max. Input Current with rated output power and charged battery <b>per Module</b> (output $\cos\phi$ = 1.0)	A	15.2	30.4
Max. Input Power with rated output power and discharged battery <b>per Module</b> (output $\cos\phi$ = 1.0)	kW	11.5	23
Max. Input Current with rated output power and discharged battery <b>per Module</b> (output $\cos\phi$ = 1.0)	A	16.6	33.3

10.3.1 GRAPH: INPUT PF VERSUS % LOAD

**Input power factor versus load (Leading)**

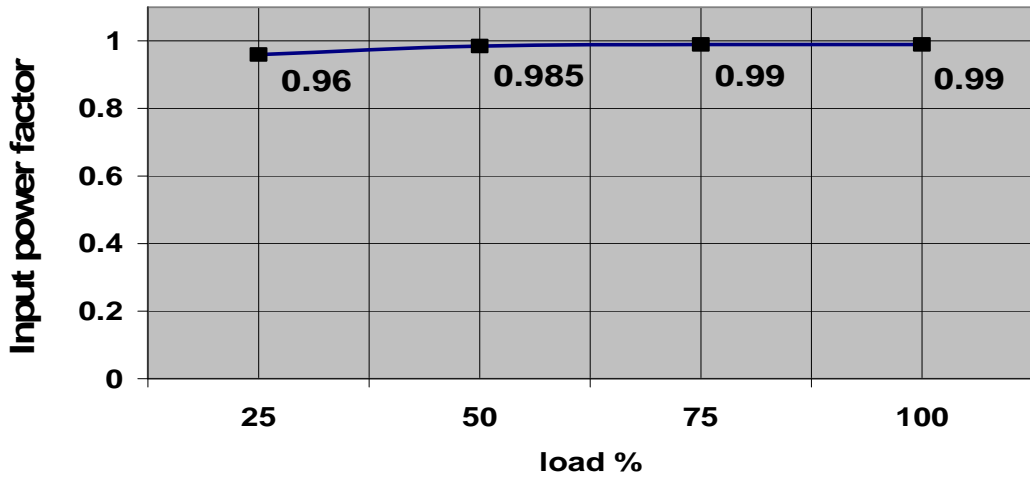

10.3.2 GRAPH: INPUT DISTORTION THDI VERSUS % LOAD

**Input Current Distortion THDi**

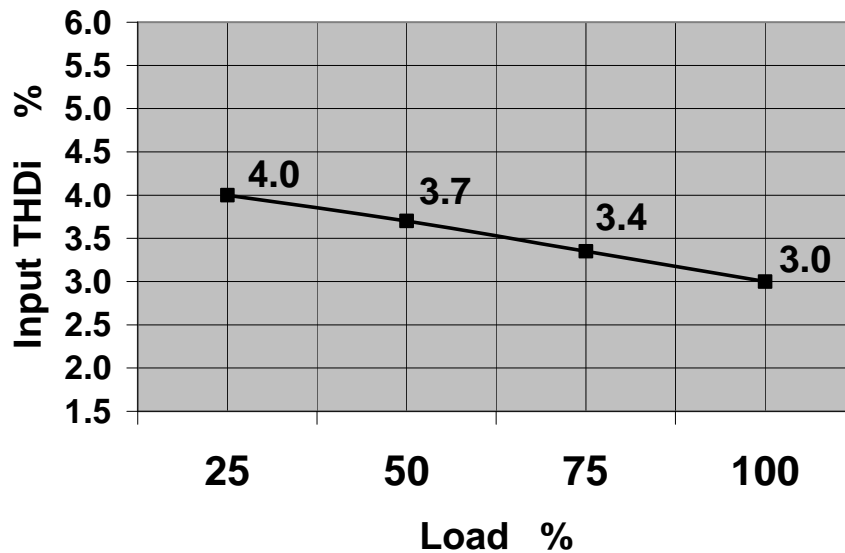

**10.4 BATTERY CHARACTERISTICS**

Module Range		UPScale M 10 or M 20	
Module Type		UPScale M 10	UPScale M 20
Variable Number of 12V Battery Blocks	No.	20-50 *1)	30-50 *1)
Maximum Battery Charger Current	A	4 A	4 A
Battery Charging Curve	Ripple free ; IU (DIN 41773)		
Temperature compensation	Standard (temp. sensor optional)		
Battery Test	Automatic and periodically (adjustable)		
Battery Type	Maintenance free VRLA or NiCd		

Note : \* 1) Depending of the effective load in kW used by the module (see table below)

Description	UPScale Module M 10					UPScale Module M 20					
	20	24	28	30	34-50	30	34	36	40	40	48-50
Number of battery blocks	20	24	28	30	34-50	30	34	36	40	40	48-50
Max. Power in KW	6	8	8	10	10	12	12	16	20	16	20
Max. autonomy (min.)	5	5	5	5	999	5	999	5	5	999	999

**10.5 OUTPUT CHARACTERISTICS**

Module Range		UPScale M 10 or M 20	
Module Type		UPScale M 10	UPScale M 20
Output Rated Power per Module $\cos\phi$ 0.8	kVA	10	20
Output Rated Power per Module $\cos\phi$ 1.0	KW	10	20
Output Current In @ $\cos\phi$ 1.0 (400 V)	A	14.5	29
Output Rated Voltage	V	3x380/220V or 3x400/230V or 3x415/240V	
Output Voltage Stability	%	Static: < +/- 1% Dynamic (Step load 0%-100% or 100%-0%) < +/- 4%	
Output Voltage Distortion	%	With Linear Load < 1.5% With Non-linear Load (EN62040-3:2001) < 3%	
Output Frequency	Hz	50 Hz or 60 Hz	
Output Frequency Tolerance	%	Synchronized with mains < +/- 2% (selectable for bypass operation) or < +/- 4% Free running +/- 0.1%	
Bypass operation		At Nominal Input voltage of 3x400 V or 190 V to 264 V ph-N +/- 15%	
Permissible Unbalanced Load (All 3 phases regulated independently)	%	100%	
Phase Angle Tolerance (With 100 % Unbalanced load)	Deg.	+/- 0 deg.	
Overload Capability on Inverter	%	125 % load 10 min. 150 % load 60 sec.	
Output short capability (RMS)	A	Inverter : 3 x In during 40 ms Bypass : 10 x In during 20 ms	
Crest - Factor		3 : 1	

**10.5.1 GRAPH: AC – AC EFFICIENCY with Linier load @ cosphi 1**

Efficiency up to 1 % higher with output PF cosphi 0.8  
 Details refer to paragraph 10.7 Environmental Characteristics

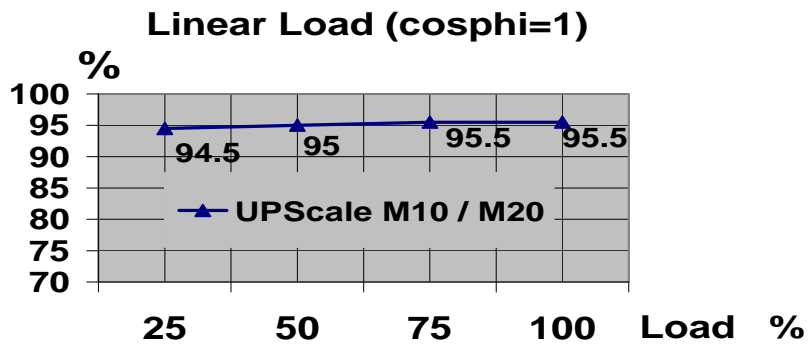

**10.5.2 GRAPH: Output Power in KW and KVA VERSUS cosphi**

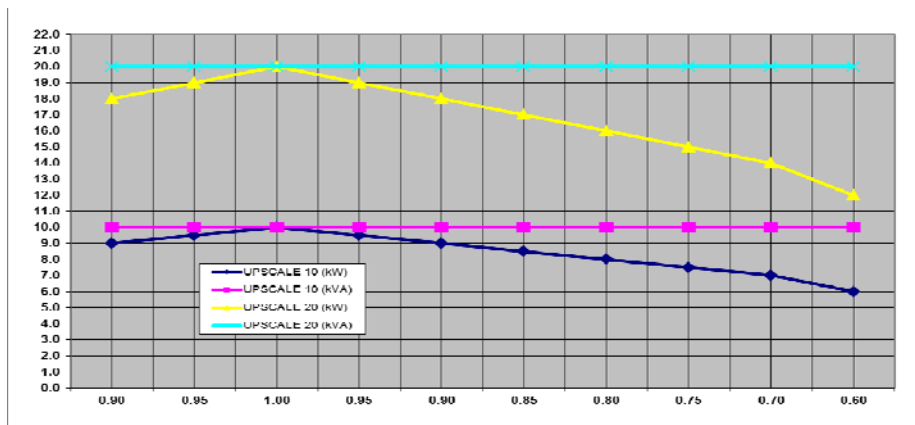

		UPScale Module		UPScale Module	
		M 10		M 20	
cosphi		kW	kVA	kW	kVA
unity	0.9	9	10	18	20
	0.95	9.5	10	19	20
	1	10	10	20	20
Ind.	0.95	10	10	19	20
	0.9	9	10	18	20
	0.85	8.5	10	17	20
	0.8	8	10	16	20
	0.75	7.5	10	15	20
	0.7	7	10	14	20
	0.6	6	10	12	20

Changes of this table without notice – modifications reserved



## 10.6 ENVIRONMENTAL CHARACTERISTICS

Module Range		UPScale M 10 or M 20	
Module Type		UPScale M 10	UPScale M 20
Audible Noise with 100% / 50% Load	dBA	55 / 49	57 / 49
Operation temperature	°C	0 – 40	
Ambient Temperature for Batteries (recommended)	°C	20 – 25	
Storage Temperature	°C	-25 – +70	
Battery Storage Time at Ambient Temperature		Max. 6 months	
Max. altitude (above sea level)	m	1000m (3300ft) without de-rating	
De-rating factor for use at altitudes above 1000m sea level according (IEC 62040-3)		Meter above sea level (m / ft)	De-Rating Factor for Power
		1500 / 4850	0.95
		2000 / 6600	0.91
		2500 / 8250	0.86
3000 / 9900	0.82		
Relative Air-humidity		Max. 95% (non-condensing)	
Accessibility		Totally front accessibility for service and maintenance (no need for side, top or rear access)	
Positioning		Min. 20 cm rear space (required for fan)	
Input and Output Power Cabling		From the bottom on the front	
Efficiency AC-AC up to (at cosphi 1.0) (depending on Module power)	%	<i>Load</i> : 100 % 75 % 50% 25% M 20 : 95.5% 95.5% 95% 94.5% M 10 : 95.5% 95.5% 95% 94.5%	
Efficiency with Linear Load at cosphi $\square=0.8$ ind Efficiency Non-linear Load (EN 62040-1-1:2003)		Typically up to 1 % higher of above values Typically up to 1 % lower of above values	
Eco-Mode efficiency at 100% load	%	98 %	

## 10.7 STANDARDS

Safety	EN 62040-1-1, EN 60950-1	
Electromagnetic Compatibility	EN 61000-6-4 Prod.standard: EN 62040-2 EN 61000-6-2 Prod.standard: EN 62040-2 EN 61000-4-2, EN 61000-4-3 - EN 61000-4-4 - EN 61000-4-5 - EN 61000-4-6	
EMC Classification for	M 10	M 20
Emission Class	C2	C2
Immunity Class	C3	C3
Performance	EN62040-3	
Product certification	CE	
Degree of protection	IP 20	

**10.8 COMMUNICATION**

Power Management Display (PMD)	1 LCD display for each module
RJ45 Plug (Not used)	RJ45 Plug (for future options)
Customer Interfaces : Outputs DRY PORT X 2	5 voltage free contacts For remote signaling and automatic computer shutdown
Customer Interfaces : Inputs DRY PORT X 1	1 x Remote Shut down [EMERGENCY OFF (Normally closed)] 2 x Programmable Customer's Inputs (1 <sup>st</sup> default as GEN-ON (Normally open)) (2 <sup>nd</sup> free Programmable Customer's Inputs (Normally open)) 1 x Temp. Sensor for Battery Control 1 x 12 Vdc output (max. 200mA)
Serial ports RS232 on Sub-D9	1 x system frame For monitoring and integration in network management
USB	1x For monitoring and software management
Slot for SNMP	SNMP card (optional) For monitoring and integration in network management

**10.8.1 POWER MANAGEMENT DISPLAY (PMD)**

The user-friendly PMD consists of three parts the MIMIC DIAGRAM, CONTROL KEYS and LCD that provides the necessary monitoring information about the UPS.

**10.8.2 MIMIC DIAGRAM**

The mimic diagram serves to give the general status of the UPS. The LED-indicators show the power flow status and in the event of mains failure or load transfer from inverter to bypass and vice-versa the corresponding LED-indicators will change color from green (normal) to red (warning). The LED's LINE 1 (rectifier) and LINE 2 (bypass) indicate the availability of the mains power supply. The LED's INVERTER and BYPASS if green indicate which of the two are supplying power to the critical load. When the LED-indicator BATTERY is lit it means that the battery due to mains failure is supplying the load. The LED-indicator ALARM is a visual indication of any internal or external alarm condition. At the same time the audible alarm will be activated.

**10.8.3 DISPLAY**

The 2 x 20 character LCD simplifies the communication with the UPS. The menu driven LCD enables the access to the EVENT REGISTER, or to monitor the input and output U, I, f, P, Autonomy Time and other Measurement's, to perform commands like start-up and shut-down of INVERTER or load transfer from INVERTER to BYPASS and vice-versa and finally it serves for the DIAGNOSIS (SERVICE MODE) for adjustments and testing (for more details see the USER MANUAL of DPA UPScale™).

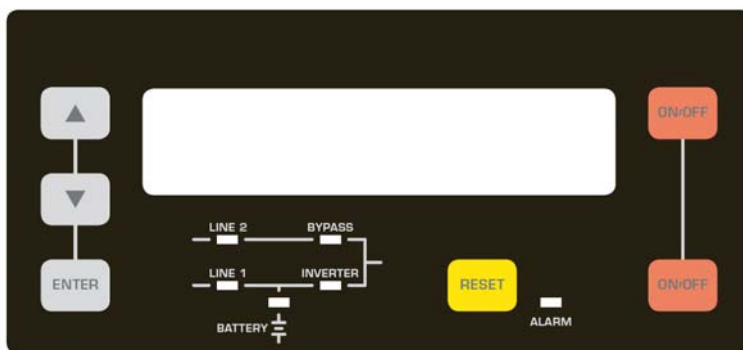

Power Management Display (PMD) of DPA UPScale™

**10.8.4 CUSTOMER INTERFACES**                      **Terminals X1...X2**















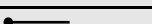

**10.8.5 CUSTOMER INPUTS DRY PORT s:**    **Terminal block X2**

Connection of Remote Shut down facilities, Generator Operation, Customers specials  
(see UM Section 9 / OPTIONS)

**10.8.6 CUSTOMER OUTPUTS DRY PORTs :** **Terminal blocks X1**

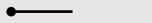
Provision of signals for the automatic and orderly shutdown of servers, AS400 or Automation building systems

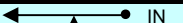
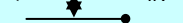
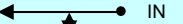
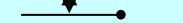
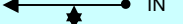
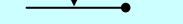
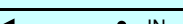
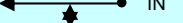
All voltage free contacts are rated 60 VAC max. and 500 mA max.:  
All the interfaces are connected to Phoenix Spring terminals with wires : 0.5 mm<sup>2</sup>

Block	Terminal	Contact	Signal	On Display	Function
X2	X2 / 1	NO 	ALARM	MAINS_OK	Mains Present
	X2 / 2	NC 		Mains Failure	
	X2 / 3	C 		Common	
	X2 / 4	NO 	Message	LOAD_ON_INV	Load on Inverter
	X2 / 5	NC 		(Load on Mains bypass)	
	X2 / 6	C 		Common	
	X2 / 7	NO 	ALARM	BATT_LOW	Battery Low
	X2 / 8	NC 		Battery OK	
	X2 / 9	C 		Common	
	X2 / 10	NO 	Message	LOAD_ON_MAINS	Load on bypass (Mains)
	X2 / 11	NC 		(Load on Inverter)	
	X2 / 12	C 		Common	
	X2 / 13	NO 	ALARM	COMMON_ALARM	Common Alarm (System)
	X2 / 14	NC 		NO Alarm Condition	
	X2 / 15	C 		Common	
X1	X1 / 1		+ 12Vdc		Customer IN 1 (default as Generator Operation )
	X1 / 2		GND		(NC = Generator ON)
	X1 / 3		+ 12Vdc		Customer IN 2
	X1 / 4		GND		(Function on request, to be defined)
	X1 / 5		+ 3.3Vdc		Temperature Battery
	X1 / 6		GND		(If connected , the battery charger current if depending of the battery temp.)
	X1 / 7		+ 12Vdc		Remote Shut down
	X1 / 8		GND		(Do not remove the factory mounted bridge until external Remote Shut down is connected)
	X1 / 9		+ 12Vdc		12 Vdc source
	X1 / 10		GND		(max. 200 mA load)

Phoenix Spring Terminals (X1...X2) Connection

**10.9 OPTIONS**

- SNMP card and WaveMon Management Software , Modbus Protocol
- External Battery Cabinets
- In/Output Transformatore for special voltages on request
- Temp. sensor for battery temp. control

**10.9.1 SNMP card / WaveMon Management Software**

The Simple Network Management Protocol (SNMP) is a worldwide-standardized communication-protocol. It is used to monitor any device in the network via simple control language. The UPS-Management Software WaveMon also provides its data in this SNMP format with its internal software agent. The operating system you are using must support the SNMP protocol. We offer our WaveMon software with SNMP functionality for Novell, OS/2, all Windows running on INTEL and ALPHA, DEC VMS, Apple. Two types of SNMP interfaces with identical functionality are available: an external SNMP-Adapter (Box) and an internal SNMP-Card. Both can manage a parallel system (N modules) and return either global values - which are consistent for the whole parallel system - or specific values from the single modules.

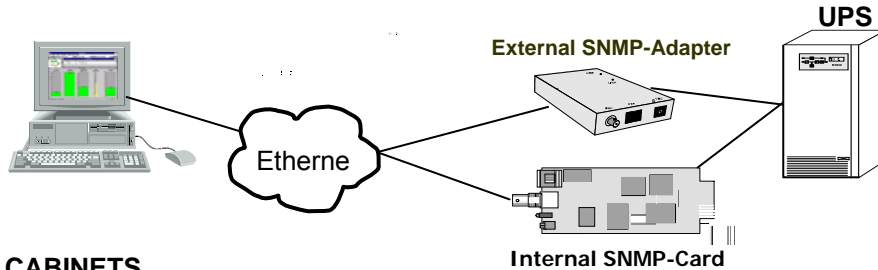

**10.9.2 BATTERY CABINETS**

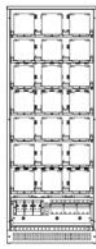
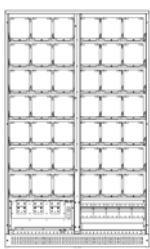
S-type = For Separate. Battery C-type = For Common. Battery		<b>CBAT-UPScale-120</b> S-type or C-type	<b>CBAT-UPScale-200</b> S-type or C-type
<b>BATTERY FRAMES</b>			
Configuration accommodates:	Max.	120 Batt. block x 24Ah/28Ah on 8 shelf 3x5=15 blocks/shelf	200 Batt. blocks x 24Ah/28Ah on 7 shelf 6x5=30 blocks/shelf
Battery fuses / Max. Batt. Strings : Terminals :	S-type	9 / 3 (Terminal 9 x 16/25mm <sup>2</sup> )	15 / 5 (Terminal 15 x 16/25mm <sup>2</sup> )
Battery fuses / Max. Batt. Strings Terminals :	C-type	9 / 3 + Com. Connection Bar 3 x (2xM8) +PE 2xM8	15 / 5 + Com. Connection Bar 3 x (2xM10) +PE 2xM10
Fuse Type (Very Fast acting)	A	3x100 A	5x100A
Dimensions (WxHxD)	mm	730x1975x800	1200x1975x800
Weight with trays and w/o batteries	kg	290	410
Possible Battery configurations within the Battery Cabinets		Battery Configurations (1x40)x28Ah (2x40)x28Ah (3x40)x28Ah (2x50)x28Ah	Battery Configurations (1x40)x28Ah (2x40)x28Ah (3x40)x28Ah (4x40)x28Ah (5x40)x28Ah (2x50)x28Ah (4x50)x28Ah

**10.10 BATTERY AUTONOMIES**

**10.10.1 Examples of Internal Battery Autonomy of DPA UPScale ST40 and ST 60**

Module Type		UPScale M 10		UPScale M 20 Module need at least 48 blocks for full power or minimum 40 blocks for 16kW		
Internal Separate Battery configuration		Battery Autonomy in (min.) per Module				
Frame Type	Separate Battery / Module	8kW	10kW	12kW	16kW	20KW
UPScale ST 40 max. 80 blocks up to 2 modules	(1x40)x7Ah / Module	8	6	5		
UPScale ST 40 max. 80 blocks 1 modules ONLY	(1x50)x7Ah / Module	11	8.	7	4	
UPScale ST 60 max. 240 blocks up to 3 modules	(1x40)x7Ah / Module	8	6	5		
UPScale ST 60 max. 240 blocks up to 3 modules	(2x40)x7Ah / Module	21	15	12	8	5

Internal Common Battery configuration		Battery Autonomy in (min.) for Tot. System Power				
With 1 Module	Module Type	1 x UPScale M 10		1 x UPScale M 20		
	Total System Power	8kW	10kW	12kW	16kW	20KW
UPScale ST 40 or UPScale ST 60	1x (2x40)x7Ah	21	15	12	8	5
UPScale ST 60	2x (1x50)x7Ah	28	21	16	11	8
UPScale ST 60	3x (1x40)x7Ah	35	26	21	14	5
UPScale ST 60	3x (1x50)x7Ah	47	35	28	19	14
UPScale ST 60	4x (1x50)x7 Ah	69	52	41	28	21
UPScale ST 60	3x (2x40)x7Ah	88	66	52	35	5
With 2 Modules	Module Type	2 x UPScale M 10		2 x UPScale M 20		
	Total System Power	16kW	20kW	24kW	32KW	40kW
UPScale ST 40 or UPScale ST 60	1x (2x40)x7Ah	8	6	5		
UPScale ST 60	2x (1x50)x7Ah	11	8	7	4	
UPScale ST 60	3x (1x40)x7Ah	14	11	8	6	5
UPScale ST 60	3x (1x50)x7Ah	19	14	11	8	6
UPScale ST 60	4x (1x50)x7 Ah	28	21	16	11	8
UPScale ST 60	3x (2x40)x7Ah	35	26	21	14	5
With 3 Modules	Module Type	3 x UPScale M 10		3 x UPScale M 20		
	Total System Power	24kW	30KW	36kW	48KW	60kW
UPScale ST 60	2x (1x50)x7Ah	7	5	4		
UPScale ST 60	3x (1x40)x7Ah	8	6	5		
UPScale ST 60	2x (2x40)x7Ah	12	9	7	5	4
UPScale ST 60	4x (1x50)x7 Ah	16	12	10	7	5
UPScale ST 60	3x (2x40)x7Ah	21	15	12	8	5

### 10.10.2 Examples of External Battery Autonomy

This configuration are mostly used in combination with the frame UPScale ST 80 or ST 120

Module Type		UPScale M 10		UPScale M 20	
External Separate Battery configuration		Battery Autonomy in (min.) per Module			
Battery Cabinet	Battery / Module	1x UPScale M 10 (at 10 kW)		1 x UPScale M 20 (at 20kW)	
	<b>Total System Power</b>	<b>8kW</b>	<b>10kW</b>	<b>16kW</b>	<b>20kW</b>
1x CBAT--UPScale -120	1x40x28Ah	54	41	22	5
1x CBAT--UPScale -120	1x50x28Ah	72	54	30	22

External Common Battery configuration (with 40bl./string)		Battery Autonomy in (min.) for Tot. System Power (3+1)	
With 3 Modules	Module Type	3 x UPScale M 10	3 x UPScale M 20
	Total System Power	30 KW	48KW
1x CBAT-UPScale-120	(2x40)x28Ah	24	13
1x CBAT-UPScale-120	(3x40)x28Ah	41	22
1x CBAT-UPScale-200	(4x40)x28Ah	59	32
1x CBAT-UPScale-200	(5x40)x28Ah	78	43
External Common Battery configuration (with 50bl./string)		Battery Autonomy in (min.) for Tot. System Power (3+1)	
With 3 Modules	Total System Power	30 KW	60 KW
	1x CBAT-UPScale-120	(1x50)x28Ah	13
1x CBAT-UPScale-120	(2x50)x28Ah	32	13
1x CBAT-UPScale-200	(3x50)x28Ah	54	22
1x CBAT-UPScale-200	(4x50)x28Ah	78	32

External Common Battery configuration (with 40bl./string)		Battery Autonomy in (min.) for Tot. System Power (5+1)	
With 5 Modules	Module Type	5 x UPScale M 10	5 x UPScale M 20
	Total System Power	50 KW	80KW
1x CBAT-UPScale-120	(2x40)x28Ah	13	7
1x CBAT-UPScale-120	(3x40)x28Ah	21	12
1x CBAT-UPScale-200	(4x40)x28Ah	31	17
1x CBAT-UPScale-200	(5x40)x28Ah	41	22
External Common Battery configuration (with 50bl./string)		Battery Autonomy in (min.) for Tot. System Power (5+1)	
With 5 Modules	Total System Power	50 KW	100 KW
	1x CBAT-UPScale-120	(1x50)x28Ah	7
1x CBAT-UPScale-120	(2x50)x28Ah	17	7
1x CBAT-UPScale-200	(3x50)x28Ah	28	12
1x CBAT-UPScale-200	(4x50)x28Ah	41	17

**10.11 INSTALLATION PLANNING**

Clearances	X	Y
Minimum	200mm	900 mm

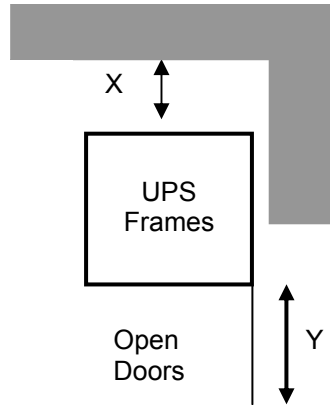

Figure 1: UPS space recommendation

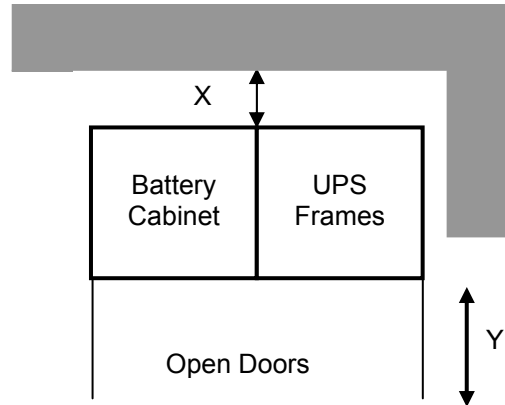

Figure 2 : : UPS + Battery space recommendation

UPS Frame type (40kW up to 120 kW)	UPScale ST 40	UPScale ST 60	UPScale ST 80	UPScale ST 120
Dimensions (WxHxD) mm	550x1135x770	550x1975x770	550x1135x770	550x1975x770
<b>External Battery Cabinet Type</b>	<b>CBAT UPScale-120</b>		<b>CBAT UPScale-200</b>	
Dimensions (WxHxD) mm	730x1975x800		1200x1975x800	
Accessibility	Totally front accessibility for service and maintenance (no need for side, top or rear access)			
Positioning	Min. 200 mm rear space (required for fan)			
Input and Output Power Cabling	From the bottom on the front			

**10.11.1 HEAT DISSIPATION PER MODULE WITH NON-LINEAR LOAD**

Module Range		UPScale M 10 or M 20	
Module Type		UPScale M 10	UPScale M 20
Heat Dissipation with 100% Non-linear Load per Module (EN 62040-1-1:2003)	W	550	1100
Heat Dissipation with 100% Non-linear Load per Module (EN 62040-1-1:2003)	BTU/h	1887	3754
Airflow (25° - 30°C) with Non-linear Load per Module (EN 62040-1-1:2003)	m <sup>3</sup> /h	150	150
Dissipation at no load	W	120	150

**10.12 WIRING AND BLOCK DIAGRAMS FOR ALL FRAMES AND MODULES**

The customer has to supply the wiring to connect the UPS to the local power source. The installation inspection and initial start up of the UPS and extra battery cabinet must be carried out by a qualified service personnel such as a licensed service engineer from the manufacturer or from an agent authorized by the manufacturer. More details and procedure are mentioned in the user manual.

**10.12.1 TERMINAL CONNECTIONS OVERVIEW**

FRAME TYPE Terminals (T) Connection Bar (B)	Battery Earth PE	Separate. Battery (+ / N / -)	Common Battery (+ / N / -)	Input Bypass 3+N	Input Rectifier 3+N+PE	Output load 3+N+PE
UPScale ST 40	16/25mm <sup>2</sup> (T)	2x (3 x 10/16mm <sup>2</sup> ) (T)	3 x M5 (B)	4 x 16/25 mm <sup>2</sup> (T)	5 x 16/25 mm <sup>2</sup> (T)	5 x 16/25 mm <sup>2</sup> (T)
UPScale ST 60	50 mm <sup>2</sup> (T)	3x (3 x 10/16mm <sup>2</sup> ) (T)	3 x M6 (B)	4 x 35 mm <sup>2</sup> (T)	4 x 35 mm <sup>2</sup> (T) +PE 50 mm <sup>2</sup> (T)	4 x 35 mm <sup>2</sup> (T) +PE 50 mm <sup>2</sup> (T)
UPScale ST 80	50 mm <sup>2</sup> (T)	4x (3 x 10/16mm <sup>2</sup> ) (T)	3 x M6 (B)	3 x 50 mm <sup>2</sup> (T) + N 70/95 mm <sup>2</sup> (T)	3 x 50 mm <sup>2</sup> (T) + N 70/95 mm <sup>2</sup> (T) +PE 50 mm <sup>2</sup> (T)	3 x 50 mm <sup>2</sup> (T) + N 70/95 mm <sup>2</sup> (T) +PE 50 mm <sup>2</sup> (T)
UPScale ST 120	50 mm <sup>2</sup> (T)	6x (3 x 10/16mm <sup>2</sup> ) (T)	3 x 2xM5 (B) or 3 x M10 (B)	4 x 70/95mm <sup>2</sup> (T)	4 x 70/95mm <sup>2</sup> (T) +PE 50 mm <sup>2</sup> (T)	4 x 70/95mm <sup>2</sup> (T) +PE 50 mm <sup>2</sup> (T)

**UPScale ST 40**

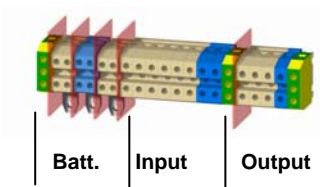

**UPScale ST 60**

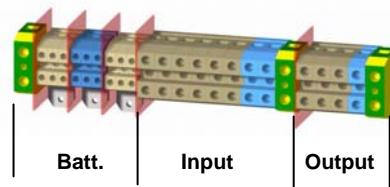

**UPScale ST 80**

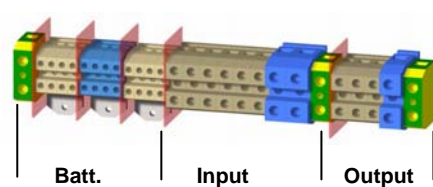

**UPScale ST 120**

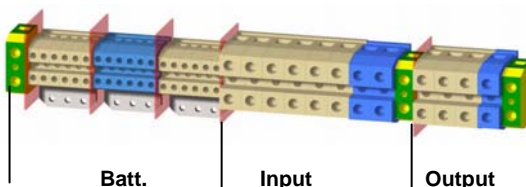



### 10.12.2 SINGLE FEED INPUT

Cable Sections and Fuse Ratings recommended. Alternatively, local standards to be respected

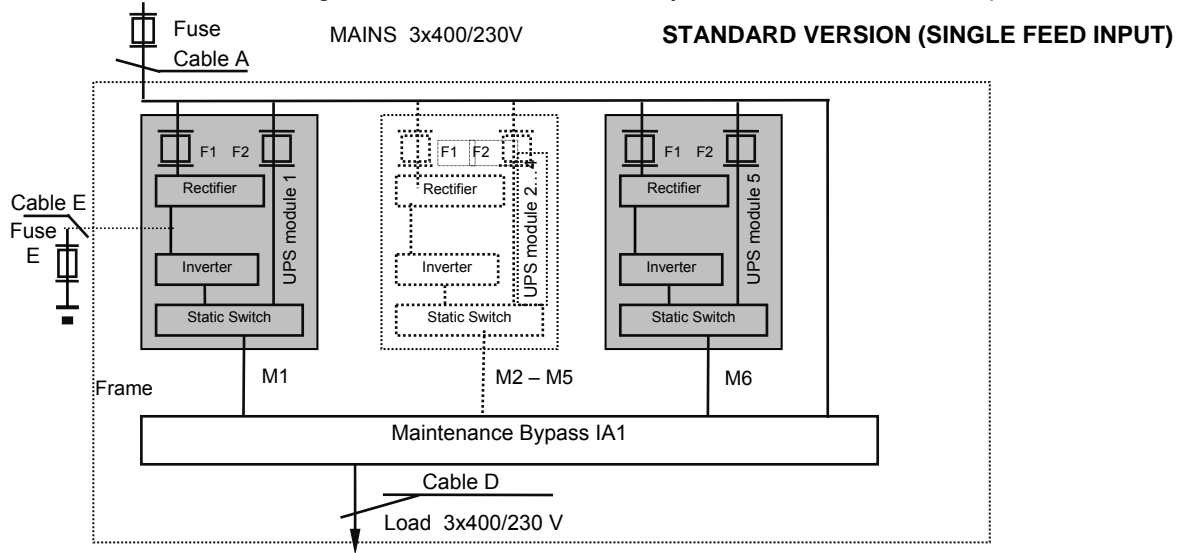

### 10.12.3 SINGLE FEED INPUT / Cable Sections

Frame type	Load in KW	Input 3x400V/230V			Output 3x400V230V @ cosphi 1.0		Battery		
		Fuse A (Agl/CB)	Cable A (mm <sup>2</sup> ) (IEC 60950-1:2001)	Max. Input Current with battery charging [A]	Cable D (mm <sup>2</sup> ) (IEC 60950-1:2001)	I <sub>nom</sub> [A]	Fuse E + / N / - (Agl/CB)	Cable E (mm <sup>2</sup> ) for CBAT UPScale 120 or 200 ONLY + / N / -	
								Com. Battery	Sep. Battery
UPSscale ST 40	40	3x80A	5x16	68 A	5x16	58 A	3x100A *1	3x25 *1	2x(3x10)
UPSscale ST 60	60	3x125A	5x35	102 A	5x35	87 A	3x160A*1	3x50 *1	3x (3x10)
UPSscale ST 80	80	3x160A	5x50	136 A	5x50	116 A	3x224A*1	3x95 *1	4x (3x10)
UPSscale ST 120	120	3x224A	5x95	208 A	5x70	174 A	3x300A*1	3x150 *1	6x (3x10)

\*1 only valid for common battery use

### 10.12.4 DUAL FEED INPUT

Cable Sections and Fuse Ratings recommended. Alternatively, local standards to be respected

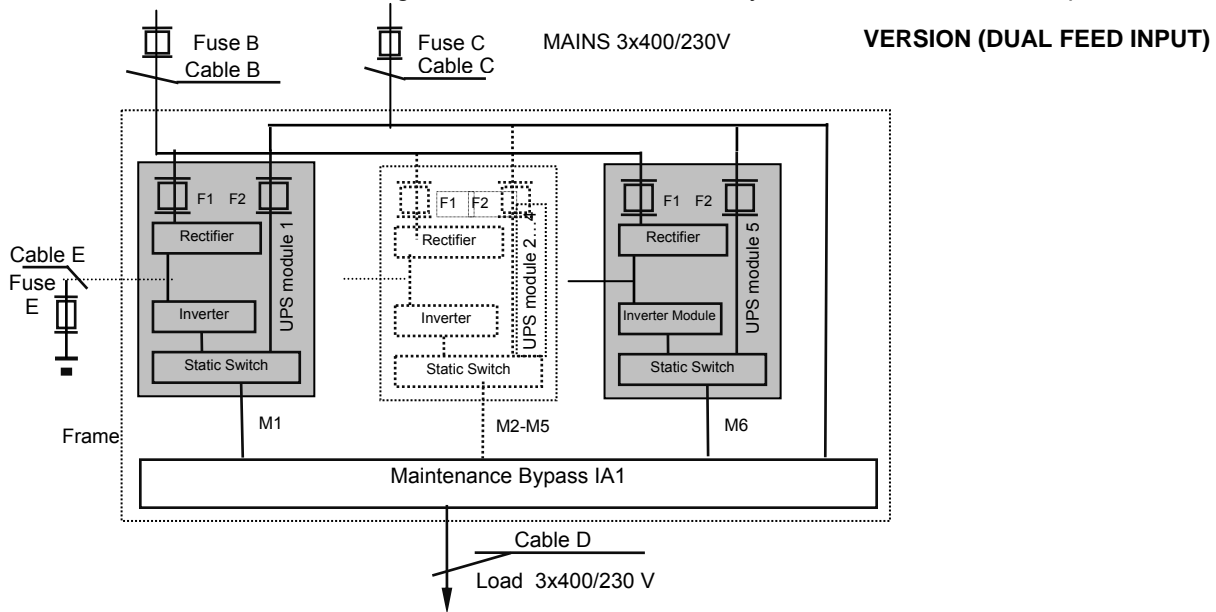

### 10.12.5 Dual FEED INPUT / Cable Sections

Frame type	Load in KW	Input 3x400V/230V			Bypass 3x400V/230V		Output 3x400V/230V @ cosphi 1.0		Battery		
		Fuse B (Agl/CB)	Cable B (mm <sup>2</sup> ) (IEC 60950-1:2001)	Max. Input Current with battery charging [A]	Fuse C (Agl/CB)	Cable C (mm <sup>2</sup> ) (IEC 60950-1:2001)	Cable D (mm <sup>2</sup> ) (IEC 60950-1:2001)	I <sub>nom</sub> [A]	Fuse E +/N/- (Agl/CB)	Cable E (mm <sup>2</sup> ) for CBAT UPSscale 120 or 200 ONLY + / N / -	
										Com. Battery	Sep. Battery
UPSscale ST 40	40	3x80A	5x16	68 A	3x80A	4x16	5x16	58 A	3x100A *1	3x25 *1	2x(3x10)
UPSscale ST 60	60	3x125A	5x35	102 A	3x125A	4x35	5x35	87 A	3x160A*1	3x50 *1	3x (3x10)
UPSscale ST 80	80	3x160A	5x50	136 A	3x160A	4x50	5x50	116 A	3x224A*1	3x95 *1	4x (3x10)
UPSscale ST 120	120	3x224A	5x95	208 A	3x224A	4x95	5x70	174 A	3x300A*1	3x150 *1	6x (3x10)

\*1 only valid for common battery use