



A MEMBER OF THE ABB GROUP

PowerScale 10 – 50 kVA

➤ Maximise your availability with PowerScale.



PowerScale TECHNICAL SPECIFICATIONS

PowerScale highlights at a glance

- Best in class efficiency
Cost savings during the entire life-cycle(TCO)
- Low input harmonic distortion
Cost saving during installation
- Input Power Factor near unity
Cost savings during installation and the entire life-cycle(TCO)
- Compact size
Floor space cost savings

Three-phase UPS system
Power range: 10-50kVA

Specifications are subject to change without notice

TABLE OF CONTENTS

10.1 POWERSCALE SYSTEM DESCRIPTION 3

10.2 TECHNICAL CHARACTERISTICS 4

 10.2.1 MECHANICAL CHARACTERISTICS POWERSCALE 10-20kVA Cabinet A 4

 10.2.2 MECHANICAL CHARACTERISTICS POWERSCALE 10-25kVA Cabinet B 4

 10.2.3 MECHANICAL CHARACTERISTICS POWERSCALE 25-50kVA Cabinet C 5

10.3 INPUT CHARACTERISTICS 5

 10.3.1 GRAPH: INPUT PF VERSUS % LOAD 6

 10.3.2 GRAPH: INPUT DISTORTION THDi VERSUS % LOAD 6

10.4 BATTERY CHARACTERISTICS 7

10.5 OUTPUT CHARACTERISTICS 8

 10.5.1 GRAPH: AC – AC EFFICIENCY with Linear load up to $\cos\phi$ 1 8

10.6 ENVIRONMENTAL CHARACTERISTICS 9

10.7 STANDARDS 9

10.8 COMMUNICATION 10

 10.8.1 POWER MANAGEMENT DISPLAY (PMD) 10

 10.8.2 MIMIC DIAGRAM 10

 10.8.3 DISPLAY 10

 10.8.4 CUSTOMER INTERFACES: Terminals X1 Standard 11

 10.8.5 CUSTOMER INPUTS DRY PORTs: Terminal block X1 11

 10.8.6 CUSTOMER OUTPUTS DRY PORTs : Terminal blocks X1 (optional relay slot card) 11

10.9 OPTIONS 12

 10.9.1 SNMP card / WaveMon Management Software 12

10.10 BATTERY AUTONOMIES 13

 10.10.1 EXAMPLES OF BATTERY AUTONOMY AT FULL LOAD WITH STANDARD CABINETS AND STANDARD BATTERY CONFIGURATION 13

10.11 INSTALLATION PLANNING 17

 10.11.1 HEAT DISSIPATION PER UPS RANGE WITH NON-LINEAR LOAD 17

10.12 WIRING AND BLOCK DIAGRAMS FOR ALL UPS FRAMES 18

 10.12.1 TERMINAL CONNECTIONS OVERVIEW 18

 10.12.2 INPUT FEED RATINGS 19

10.1 POWERSCALE SYSTEM DESCRIPTION

In environments that demand zero downtime, continuous power protection availability is essential. In order to respond to today's dynamic IT and process-related environments that experience daily change through new server technologies, migration and centralization, resilient and easily adaptable power protection concepts are required. POWERSCALE is the foundation for continuous power protection availability of network-critical infrastructures in enterprise data centers where business continuity has paramount importance and in process control environment where manufacturing continuity is essential.

POWERSCALE is an advanced double conversion UPS, VFI (Voltage and Frequency Independent) topology that responds fully to both highest availability and environmentally friendly requirements compliant with IEC 62040-3 (VFI-SS-111) standards.

The POWERSCALE UPS features innovations that combine to deliver the industry's best key values like: enhanced power performance, parallel capability and connectivity's interaction.

When operating in parallel configuration, each POWERSCALE can take the leadership role avoiding single points of failure in the parallel chain ensuring the highest level of power availability.

The most demanding IT infrastructures start with low power before achieving its full capacity. It is in this case essential to be able to recover the missing power requirement without risk for the applied load. POWERSCALE allows for system upgrades to meet the highest level of availability interruption free and without a temporary transfer the load to row mains (by-pass).

This Technical Specification provides detailed technical information on the mechanical, electrical and environmental performance of the POWERSCALE that can support to give answers to tender and end-user requirements. The POWERSCALE was designed to respond to the most stringent safety, EMC and other important UPS standards.

POWERSCALE is a stand-alone UPS which can be paralleled for power protection increase and/or for redundancy purpose. It offers 7 different power ranges: 10-15-20-25-30-40-50kVA in three different cabinet sizes. Up to 20 UPS can be paralleled together and provide any redundant power capacity with common or separate battery configuration.

10.2 TECHNICAL CHARACTERISTICS

10.2.1 MECHANICAL CHARACTERISTICS POWERSCALE 10-20kVA Cabinet A

PowerScale Cabinet A				
				
Power range	kVA	10	15	20
Dimensions (WxHxD)	mm	345x720x710		
Weight without battery	kg	60	62	64
Weight with battery with 48 block of 7Ah	kg	180	182	184
with standard packaging	kg	+ 4		
Colour		Graphite grey Pulverlacke No. 4222903402 serie 09RCCAT1 (RAL 7024)		

10.2.2 MECHANICAL CHARACTERISTICS POWERSCALE 10-25kVA Cabinet B

PowerScale Cabinet B					
					
Max. Power connection	kVA	10	15	20	25
Dimensions (WxHxD)	mm	345x1045x710			
Weight without battery	kg	88	90	92	94
Weight with battery with 96 block of 7Ah	kg	328	330	332	334
with standard packaging	kg	+ 5			
Colour		Graphite grey Pulverlacke No. 4222903402 serie 09RCCAT1 (RAL 7024)			

10.2.3 MECHANICAL CHARACTERISTICS POWERSCALE 25-50kVA Cabinet C

PowerScale Cabinet C					
					
Max. Power connection	kVA	25	30	40	50
Dimensions (WxHxD)	mm	440x1400x910			
Weight without battery	kg	(9Ah/28Ah) 151/135	(9Ah/28Ah) 160/145	9Ah/28Ah 165/150	9Ah/28Ah 170/155
Weight with battery					
144 blocks of 7/9Ah	kg	540	550	555	560
48 blocks of 28Ah	kg	605	615	620	625
with standard packaging	kg	+ 5			
Colour		Graphite grey Pulverlacke No. 4222903402 serie 09RCCAT1 (RAL 7024)			

10.3 INPUT CHARACTERISTICS

UPS Model		PS 10	PS 15	PS 20	PS 25	PS 30	PS 40	PS 50
Output Power rating	kVA	10	15	20	25	30	40	50
Nominal Input Voltage	V	3x380/220V+N, 3x400V/230V+N, 3x415/240V+N						
Input Voltage Tolerance (ref to 3x400/230V) for Loads in %:	V	(-23%/+15%) 3x308/177 V to 3x460/264 V for <100 % load (-30%/+15%) 3x280/161 V to 3x460/264 V for < 80 % load (-40%/+15%) 3x240/138 V to 3x460/264 V for < 60 % load						
Input Frequency	Hz	35 – 70						
Input Power Factor		PF=0.99 @ 100 % load						
Inrush Current	A	max. In						
Input Distortion THDi		Sine-wave THDi < 3 % @ 100% load						
Max. Input Power with rated output power and charged battery (output cosφ = 0.9)	kW	9.6	14.4	19.1	23.9	28.7	38.3	47.9
Max. Input Current with rated output power and charged battery (output cosφ = 0.9)	A	13.9	20.8	27.8	34.7	41.6	55.5	69.4
Max. Input Power with rated output power and discharged battery (output cosφ = 0.9)	kW	10.5	15.7	21	26.2	31.4	41.9	52.4
Max. Input Current with rated output power and discharged battery (output cosφ = 0.9)	A	15.2	22.8	30.4	37.9	45.5	60.7	75.9

10.3.1 GRAPH: INPUT PF VERSUS % LOAD

Input Power factor (Leading)

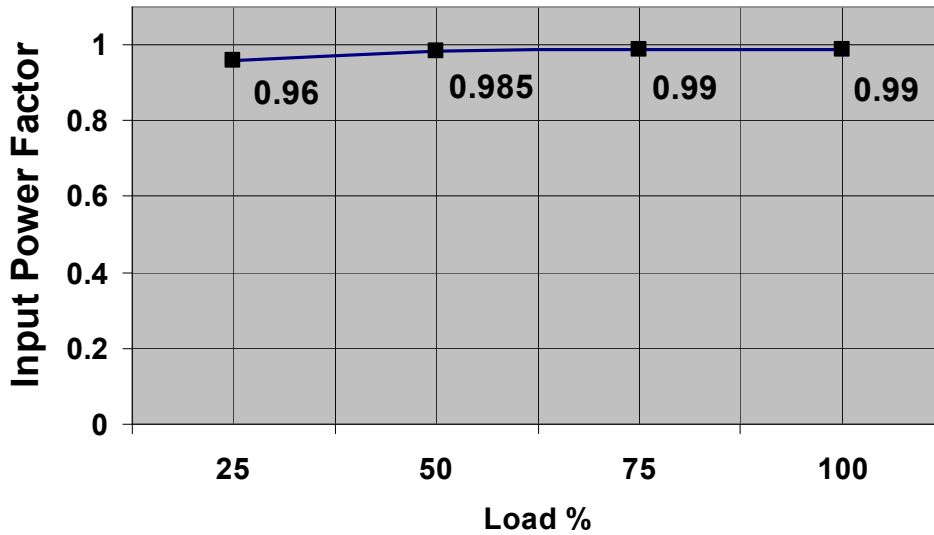

10.3.2 GRAPH: INPUT DISTORTION THDi VERSUS % LOAD

Input Current Distortion THDi

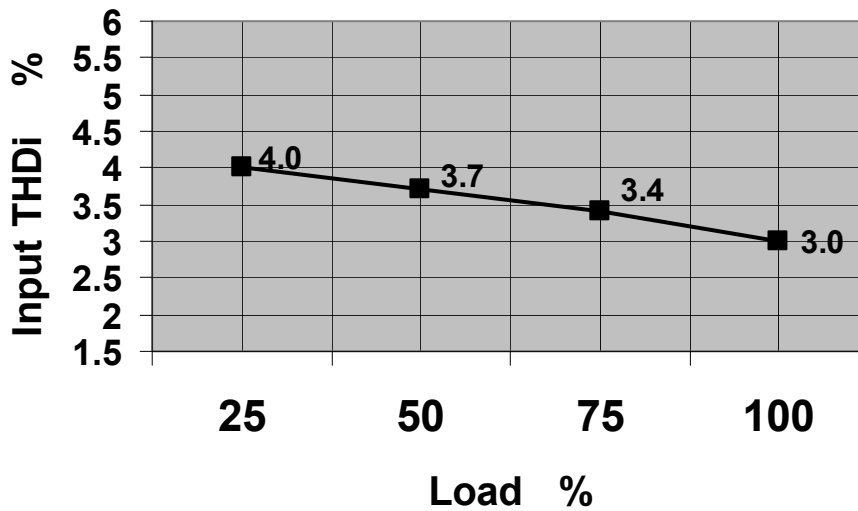

NOTE: Depending on power ratings

10.4 BATTERY CHARACTERISTICS

UPS Range		10kVA	15kVA	20kVA		25kVA	30kVA	40kVA	50kVA	
Cabinet Type		A B	A B	A	B	B C	C	C	C	
Min/Max number of 12V Battery Blocks per string	No.	16-50(*)	20-50(*)	24-50(*)	20-50(*)	24-50(*)	16-50(*)	18-50(*)	30-50(*)	
Maximum Battery Charger Current	A	4A					6A			
Battery Charging Curve	Ripple free ; IU (DIN 41773)									
Temperature compensation ready	Standard (temp. sensor optional)									
Battery Test	Automatic and periodically (adjustable)									
Battery Type	Maintenance free VRLA or NiCd									

Note : (*) Depending of the effective load in kW used by system (see table below and table in chapter 10.10.1).

Max no. for internal batteries is 48, max no. for extern batteries is 50

Description	10 kVA						15 kVA						20 kVA						25 kVA							
Cabinet Type	A			B			A			B			A			B			B							
Maximum Power in [kW]	6	8	9	6	8	9	8	10	12	13.5	8	10	12	13.5	9	12	16	18	9	12	16	18	12	16	20	22.5
Minimum number of battery blocks per String	20	22	24	16	22	24	22	28	32	34	22	28	32	34	24	28	32	36	24	28	32	36	24	32	40	46
Maximum number of battery blocks intern the PSC cabinet	48	48	48	2x 48	2x 48	2x 48	48	48	48	48	2x 48	2x 48	2x 48	2x 48	48	48	48	48	2x 48	2x 48	2x 48	2x 48	2x 48	2x 48	2x 48	2x 48

Description	25 kVA				30 kVA				40 kVA				50 kVA			
Cabinet Type	C				C				C				C			
Maximum Power in [kW]	12	16	20	22.5	16	20	24	27	18	25	32	36	30	35	40	45
Minimum number of battery blocks per String	24	32	40	46	16	20	24	28	18	26	32	36	30	34	40	46
Maximum number of internal battery blocks 7/9 Ah	3x48	3x48	3x48	3x48	3x48	3x48	3x48	3x48	3x48	3x48	3x48	3x48	3x48	3x48	3x48	3x48
Maximum number of internal battery blocks 28 Ah	1x48	1x48	1x48	1x48	1x48	1x48	1x48	1x48	1x48	1x48	1x48	1x48	1x48	1x48	1x48	1x48

10.5 OUTPUT CHARACTERISTICS

UPS Model		PS 10	PS 15	PS 20	PS 25	PS 30	PS 40	PS 50
Output Rated Power	kVA	10	15	20	25	30	40	50
Output Rated Power	KW	9	13.5	18	22.5	27	36	45
Output Current In @ PF0.9 (400VAC)	A	14.4	21.7	28.9	36.1	43.3	57.7	72.2
Output Current In @ PF1 (400VAC)	A	13.0	19.5	26.0	32.5	39.0	52.0	65.0
Output Rated Voltage	V	3x380/220V or 3x400/230V or 3x415/240V						
Output Voltage Stability	%	Static: Dynamic (Step load 0%-100% or 100%-0%)						< +/- 1% < +/- 4%
Output Voltage Distortion	%	With Linear Load With Non-linear Load (EN62040-3:2001)						< 2% < 4%
Output Frequency	Hz	50 Hz or 60 Hz						
Output Frequency Tolerance	%	Synchronized with mains (selectable for bypass operation) Free running						< +/- 2% or < +/- 4% +/- 0.1%
Bypass operation		At Nominal Input voltage of 3x400 V or 196 V to 264 V ph-N						+/- 15%
Permissible Unbalanced Load (All 3 phases regulated independently)	%	100%						
Phase Angle Tolerance (With 100 % Unbalanced load)	Deg.	+/- 0 deg.						
Overload Capability on Inverter	%	At PF 0.9	110% load					10 min.
		At PF 0.9	130% load					1 min.
		At PF 0.8	125% load					10 min.
		At PF 0.8	150% load					1 min.
Output short capability (RMS)	A	Inverter :						up to 3 x In during 40 ms
		Bypass :						10 x In during 10 ms
Crest - Factor		3 : 1						

10.5.1 GRAPH: AC – AC EFFICIENCY with Linear load up to $\cos\phi$ 1

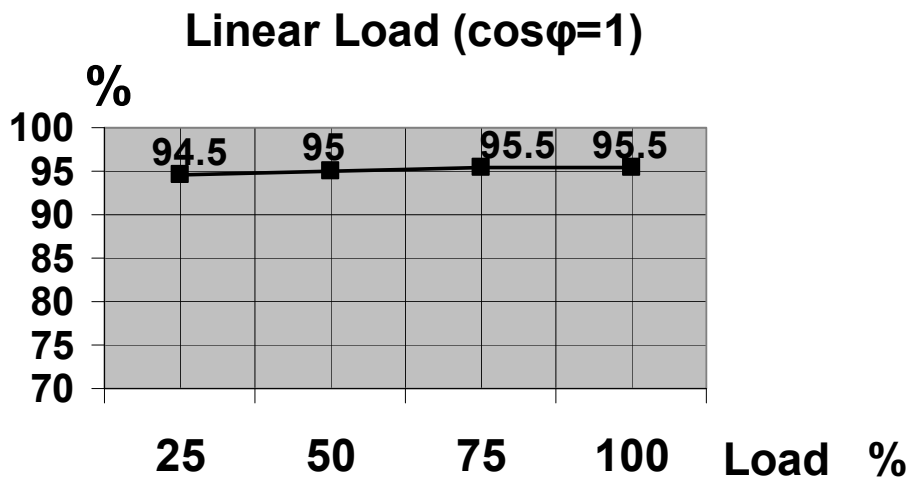

NOTE: Depending on power rating

10.6 ENVIRONMENTAL CHARACTERISTICS

UPS range		10kVA	15kVA	20kVA	25kVA	30kVA	40kVA	50kVA
Audible Noise with 100% / 50% Load	dBA	55/49	55/49	57/49	57/49	58/50	59/50	59/50
Operation temperature	°C	0 – 40						
Ambient Temperature for Batteries (recommended)	°C	20 – 25						
Storage Temperature	°C	-25 – +70						
Battery Storage Time at Ambient Temperature		Max. 6 months						
Max. altitude (above sea level)	m	1000m (3300ft) without de-rating						
De-rating factor for use at altitudes above 1000m sea level according (IEC 62040-3)		Meter above sea level (m / ft)			De-Rating Factor for Power			
		1500 / 4850			0.95			
		2000 / 6600			0.91			
		2500 / 8250			0.86			
		3000 / 9900			0.82			
Relative Air-humidity		Max. 95% (non-condensing)						
Accessibility		Rear access			Front access			
Positioning		Min. 20 cm rear space (required for fan)						
Input and Output Power Cabling		Rear side bottom			Front side bottom			
Efficiency AC-AC (at cosφ1.0) (depending on power rating)	%	<i>Load</i>	: 100 %	75 %	50%	25%		
			95.5%	95.5%	95%	94.5%		
Eco-Mode efficiency at 100% load	%	98 %						

10.7 STANDARDS

Safety	IEC/EN 62040-1, IEC/EN 60950-1	
Electromagnetic Compatibility	IEC/EN 62040-2, IEC/EN61000-3-2, IEC/EN61000-6-2	
EMC Classification for	10kVA	15-50kVA
Emission Class	C2	C3
Immunity Class	C3	
Performance	IEC/EN62040-3	
Product certification	CE	
Degree of protection	IP 20	

10.8 COMMUNICATION

STANDARD ITEMS

RS232 on Sub-D9 port	For monitoring and integration in network management
Customer Interfaces : Inputs DRY PORT	1 Remote Shut down [EMERGENCY OFF (Normally closed)] 1 GEN-ON (Normally open) 1 Programmable Customer's Inputs (Normally open) 1 Temp. Sensor for Battery Control 1 12 vdc source (max. 250 mA)
RJ45 port	For multidrop purpose
Power Management Display (PMD)	LCD display

OPTIONAL ITEMS

Relay card + USB Including: Customer Interfaces: 5 output DRY PORTS	<ul style="list-style-type: none"> • Common alarm • Load on bypass • Battery low • Load on inverter • Mains failure
RS232 on USB port	For remote signalling and automatic computer shutdown
SNMP Card (slot already included)	SNMP card For monitoring and integration in network management

10.8.1 POWER MANAGEMENT DISPLAY (PMD)

The user-friendly PMD consists of three parts the MIMIC DIAGRAM, CONTROL KEYS and LCD that provides the necessary monitoring information about the UPS.

10.8.2 MIMIC DIAGRAM

The mimic diagram serves to give the general status of the UPS. The LED-indicators show the power flow status and in the event of mains failure or load transfer from inverter to bypass and vice-versa the corresponding LED-indicators will change colour from green (normal) to red (warning). The LED's LINE 1 (rectifier) and LINE 2 (bypass) indicate the availability of the mains power supply. The LED's INVERTER and BYPASS if green indicate which of the two are supplying power to the critical load. The LED-indicator BATTERY is normally lit green, and when it supplies the load is blinking. The LED-indicator ALARM is a visual indication of any internal or external alarm condition. At the same time the audible alarm will be activated.

10.8.3 DISPLAY

The 2 x 20 character LCD simplifies the communication with the UPS. The menu driven LCD enables the access to the EVENT REGISTER, or to monitor the input and output U, I, f, P, Autonomy Time and other Measurement's, to perform commands like start-up and shut-down of UPS or load transfer from UPS to BYPASS and vice-versa and finally it serves for the DIAGNOSIS (SERVICE MODE) for adjustments and testing.

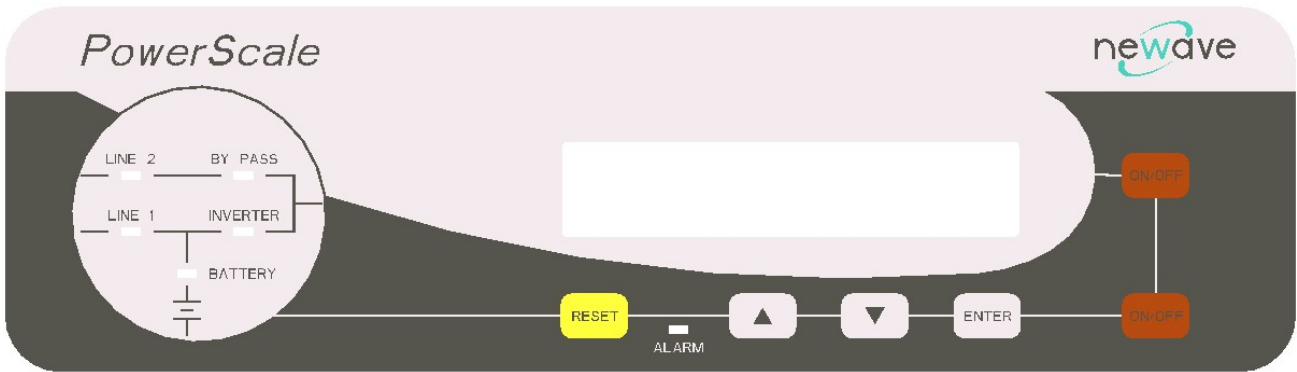

Power Management Display (PMD) of POWERSCALE

10.8.4 CUSTOMER INTERFACES: Terminals X1 Standard

10.8.5 CUSTOMER INPUTS DRY PORTS: Terminal block X1

Connection of Remote Shut down facilities, Generator Operation, Customers specials
(see UM Section 9 / OPTIONS)

10.8.6 CUSTOMER OUTPUTS DRY PORTS : Terminal blocks X1 (optional relay slot card)

Provision of signals for the automatic and orderly shutdown of servers, AS400 or Automation building systems
All voltage free contacts are rated 60 VAC max. and 500 mA max.:
All the interfaces are connected to Phoenix Spring terminals with wires : 0.5 mm²

STANDARD

Block	Terminal	Contact	Signal	On Display	Function
X1	X1 / 10	GND	GND		12 Vdc source (Max 200mA load)
	X1 / 9	IN	+12Vdc		
	X1 / 8	GND	GND		Remote Shut down (Do not remove the factory mounted bridge until an external remote shut down is connected)
	X1 / 7	IN	+12Vdc		
	X1 / 6	GND	GND		Temperature Battery (If connected, the battery charger current is batt. temperature dependent)
	X1 / 5	IN	+3.3Vdc		
	X1 / 4	GND	GND		Customer IN 1 (Function on request, to be defined)
	X1 / 3	IN	+12Vdc		
	X1 / 2	GND	GND		GEN_OPERATION (NC = Generator ON)
X1 / 1	IN	+12Vdc			

OPTION (relay card and USB (Slot))

X1	X1 / 15	C	ALARM	COMMON_ALARM	Common
	X1 / 14	NC			NO Alarm Condition
	X1 / 13	NO			Common Alarm (System)
	X1 / 12	C	Message	LOAD_ON_MAINS	Common
	X1 / 11	NC			(Load on Inverter)
	X1 / 10	NO			Load on bypass (Mains)
	X1 / 9	C	ALARM	BATT_LOW	Common
	X1 / 8	NC			Battery OK
	X1 / 7	NO			Battery Low
	X1 / 6	C	Message	LOAD_ON_INV	Common
	X1 / 5	NC			(Load on Mains bypass)
	X1 / 4	NO			Load on Inverter
	X1 / 3	C	ALARM	MAINS_OK	Common
	X1 / 2	NC			Mains Failure
	X1 / 1	NO			Mains Present
	+ USB				

Phoenix Spring Terminals (X1) Connection

10.9 OPTIONS

- SNMP card and WaveMon Management Software , Modbus Protocol, USB
- External Battery Cabinets
- Parallel kit
- In/output Transformer for special voltages
- Back-feed protection
- Temp. sensor for battery temp. control
- Relays and USB card

10.9.1 SNMP card / WaveMon Management Software

The Simple Network Management Protocol (SNMP) is a worldwide-standardized communication-protocol. It is used to monitor any device in the network via simple control language. The UPS-Management Software WaveMon also provides its data in this SNMP format with its internal software agent. The operating system you are using must support the SNMP protocol. We offer our WaveMon software with SNMP functionality for Novell, OS/2, all Windows running on INTEL and ALPHA, DEC VMS, Apple.

Two types of SNMP interfaces with identical functionality are available: an external SNMP-Adapter (Box) and an internal SNMP-Card. Both can manage a parallel system (N modules) and return either global values - which are consistent for the whole parallel system - or specific values from the single modules.

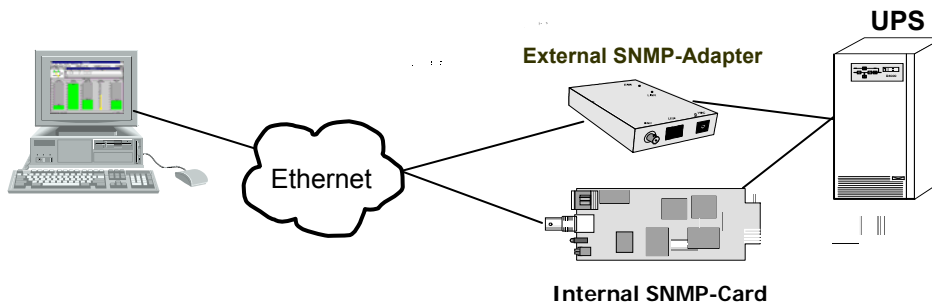

10.10 BATTERY AUTONOMIES

10.10.1 EXAMPLES OF BATTERY AUTONOMY AT FULL LOAD WITH STANDARD CABINETS AND STANDARD BATTERY CONFIGURATION

Powerscale 10kVA, 9kW						
	Load Power					
	6kW		8kW		9kW	
Autonomy (min)	7Ah batt	9Ah batt	7Ah batt	9Ah batt	7Ah batt	9Ah batt
6	1 x 24	1 x 20	1 x 32	1 x 22	1 x 34	1 x 24
8	1 x 28	1 x 22	1 x 38	1 x 26	1 x 42	1 x 28
10	1 x 32	1 x 24	1 x 46	1 x 32	1 x 48	1 x 34
12	1 x 40	1 x 28	2 x 26	1 x 36	2 x 30	1 x 40
15	1 x 48	1 x 32	2 x 32	1 x 42	2 x 36	1 x 48
18	2 x 28	1 x 38	2 x 36	1 x 48	2 x 40	2 x 28
20	2 x 30	1 x 40	2 x 40	2 x 28	2 x 44	2 x 30
22					2 x 48	2 x 32
25	2 x 36	1 x 48	2 x 48	2 x 32	n.a.	2 x 36
30	2 x 40	2 x 28	n.a.	2 x 38	n.a.	2 x 42
35	2 x 46	2 x 32	n.a.	2 x 42	n.a.	2 x 48
40	n.a.	2 x 36	n.a.	2 x 48	n.a.	n.a.
60	n.a.	2 x 48	n.a.	n.a.	n.a.	n.a.
Limit batt min A	20 blocs		20 blocs		24 blocs	
Limit batt min B						
		Cabinet A: max 1 x 48 x 7/9Ah batteries				
		Cabinet B: max 2 x 48 x 7/9Ah batteries				

Powerscale 15kVA, 13.5kW								
	Load Power							
	8kW		10kW		12kW		13.5kW	
Autonomy (min)	7Ah batt	9Ah batt	7Ah batt	9Ah batt	7Ah batt	9Ah batt	7Ah batt	9Ah batt
6	1 x 32	1 x 22	1 x 40	1 x 28	1 x 48	1 x 32		1 x 34
8	1 x 38	1 x 26	1 x 48	1 x 34	2 x 28	1 x 40	2 x 34	1 x 42
10	1 x 46	1 x 32	2 x 28	1 x 40	2 x 34	1 x 48	2 x 40	1 x 48
12	2 x 26	1 x 36	2 x 34	1 x 48	2 x 40	2 x 28	2 x 48	
15	2 x 32	1 x 42	2 x 40	2 x 28	2 x 48	2 x 32	n.a.	2 x 34
18	2 x 36	1 x 48	2 x 46	2 x 32	n.a.	2 x 38	n.a.	2 x 42
20	2 x 40	2 x 28	2 x 48	2 x 36	n.a.	2 x 40	n.a.	2 x 48
25	2 x 48	2 x 32	n.a.	2 x 40	n.a.	2 x 48	n.a.	n.a.
30	n.a.	2 x 38	n.a.	2 x 48	n.a.	n.a.	n.a.	n.a.
35	n.a.	2 x 42	n.a.	n.a.	n.a.	n.a.	n.a.	n.a.
40	n.a.	2 x 48	n.a.	n.a.	n.a.	n.a.	n.a.	n.a.
60	n.a.	n.a.	n.a.	n.a.	n.a.	n.a.	n.a.	n.a.
Limit batt min A	22 blocs		28 blocs		32 blocs		34 blocs	
Limit batt min B								
		Cabinet A: max 1 x 48 x 7/9Ah batteries						
		Cabinet B: max 2 x 48 x 7/9Ah batteries						

Powerscale 20kVA, 18kW									
Autonomy (min)	Load Power								
	9kW		12kW		16kW		18kW		
	7Ah batt	9Ah batt	7Ah batt	9Ah batt	7Ah batt	9Ah batt	7Ah batt	9Ah batt	
4					1 x 48				
6	1 x 34	1 x 24	1 x 48	1 x 32	2 x 32	1 x 44	2 x 36	1 x 46	
7						1 x 48	2 x 38		
8	1 x 42	1 x 30	2 x 28	1 x 40	2 x 38		2 x 42		
10	2 x 26	1 x 36	2 x 34	1 x 48	2 x 46	2 x 32	2 x 48	2 x 36	
11					2 x 48		n.a.	2 x 38	
12	2 x 30	1 x 40	2 x 40	2 x 28	n.a.	2 x 36	n.a.	2 x 40	
15	2 x 36	1 x 48	2 x 48	2 x 32	n.a.	2 x 42	n.a.	2 x 48	
17			n.a.		n.a.	2 x 48	n.a.	n.a.	
18	2 x 40	2 x 28	n.a.	2 x 38	n.a.	n.a.	n.a.	n.a.	
20	2 x 44	2 x 32	n.a.	2 x 40	n.a.	n.a.	n.a.	n.a.	
25	2 x 48	2 x 36	n.a.	2 x 48	n.a.	n.a.	n.a.	n.a.	
30	n.a.	2 x 42	n.a.	n.a.	n.a.	n.a.	n.a.	n.a.	
35	n.a.	2 x 48	n.a.	n.a.	n.a.	n.a.	n.a.	n.a.	
Limit batt min A	24 blocs		28 blocs		32 blocs		36 blocs		
Limit batt min B									
		Cabinet A: max 1 x 48 x 7/9Ah batteries							
		Cabinet B: max 2 x 48 x 7/9Ah batteries							

Powerscale 25kVA, 22.5kW												
Autonomy (min)	Load Power											
	12kW			16kW			20kW			22.5kW		
	7Ah batt	9Ah batt	28Ah batt	7Ah batt	9Ah batt	28Ah batt	7Ah batt	9Ah batt	28Ah batt	7Ah batt	9Ah batt	28Ah batt
6	1 x 48	1 x 32		2 x 32	1 x 44		2 x 40	2 x 40**		2 x 46		
8	2 x 28	1 x 40		2 x 38	1 x 48		2 x 48	2 x 40**		2 x 48		
10	2 x 34	1 x 48		2 x 46	2 x 32		3 x 40**	2 x 40		3 x 46	2 x 46	
12	2 x 40	2 x 28		2 x 48	2 x 36		3 x 44	2 x 44		3 x 48	2 x 48	
13							3 x 48	2 x 48		n.a.		
15	2 x 48	2 x 32	1 x 24	3 x 42	2 x 44		n.a.	3 x 40**		n.a.		
18	3 x 36	2 x 38	1 x 24	3 x 48	2 x 48	1 x 34	n.a.	3 x 42	1 x 40	n.a.	3 x 46	1 x 48
20	3 x 38	2 x 40	1 x 28	n.a.	3 x 36		n.a.	3 x 46		n.a.	3 x 48	n.a.
22	3 x 42	2 x 44	1 x 30	n.a.	3 x 38	1 x 40	n.a.	3 x 48	1 x 48	n.a.	n.a.	n.a.
24			1 x 32	n.a.			n.a.	n.a.	n.a.	n.a.	n.a.	n.a.
25	3 x 46	2 x 48		n.a.	3 x 42	1 x 44	n.a.	n.a.	n.a.	n.a.	n.a.	n.a.
27	3 x 48	3 x 34		n.a.	3 x 48		n.a.	n.a.	n.a.	n.a.	n.a.	n.a.
28	n.a.		1 x 36	n.a.	n.a.	1 x 48	n.a.	n.a.	n.a.	n.a.	n.a.	n.a.
29	n.a.	3 x 36		n.a.	n.a.	n.a.	n.a.	n.a.	n.a.	n.a.	n.a.	n.a.
31	n.a.	3 x 38		n.a.	n.a.	n.a.	n.a.	n.a.	n.a.	n.a.	n.a.	n.a.
32	n.a.		1 x 40	n.a.	n.a.	n.a.	n.a.	n.a.	n.a.	n.a.	n.a.	n.a.
33	n.a.	3 x 40		n.a.	n.a.	n.a.	n.a.	n.a.	n.a.	n.a.	n.a.	n.a.
35	n.a.	3 x 42		n.a.	n.a.	n.a.	n.a.	n.a.	n.a.	n.a.	n.a.	n.a.
36	n.a.		1 x 44	n.a.	n.a.	n.a.	n.a.	n.a.	n.a.	n.a.	n.a.	n.a.
37	n.a.	3 x 44		n.a.	n.a.	n.a.	n.a.	n.a.	n.a.	n.a.	n.a.	n.a.
39	n.a.	3 x 46		n.a.	n.a.	n.a.	n.a.	n.a.	n.a.	n.a.	n.a.	n.a.
41	n.a.	3 x 48	1 x 48	n.a.	n.a.	n.a.	n.a.	n.a.	n.a.	n.a.	n.a.	n.a.
Limit batt min B	24 blocs			32 blocs			40 blocs			46 blocs		
Limit batt min C												
		Cabinet B: max 2 x 48 x 7/9Ah batteries										
		Cabinet C: max 3 x 48 x 7/9Ah batteries										
		** The Nr of battery blocs is limited to 40 at 20kW										

Powerscale 30kVA, 27kW												
Autonomy (min)	Load Power											
	16kW			20kW			24kW			27kW		
	7Ah batt	9Ah batt	28Ah batt	7Ah batt	9Ah batt	28Ah batt	7Ah batt	9Ah batt	28Ah batt	7Ah batt	9Ah batt	28Ah batt
6	2 x 34	1 x 40		2 x 40			2 x 48			3 x 36		
7		1 x 48	1 x 16			1 x 20			1 x 24			1 x 28
8	2 x 40			2 x 48							3 x 28	1 x 30
10	2 x 44	2 x 32			2 x 40			2 x 48		3 x 48		1 x 36
12	2 x 48	2 x 40		3 x 44	2 x 44		3 x 48			n.a.		1 x 42
13				3 x 48	2 x 48		n.a.			n.a.	3 x 48	1 x 44
15	3 x 42	2 x 44		n.a.			n.a.	3 x 48		n.a.	n.a.	1 x 48
18	3 x 48	2 x 48	1 x 34	n.a.	3 x 42	1 x 40	n.a.	n.a.	1 x 48	n.a.	n.a.	n.a.
20	n.a.	3 x 36		n.a.	3 x 46		n.a.	n.a.	n.a.	n.a.	n.a.	n.a.
22	n.a.	3 x 38	1 x 40	n.a.	3 x 48	1 x 48	n.a.	n.a.	n.a.	n.a.	n.a.	n.a.
24	n.a.			n.a.	n.a.	n.a.	n.a.	n.a.	n.a.	n.a.	n.a.	n.a.
25	n.a.	3 x 42	1 x 44	n.a.	n.a.	n.a.	n.a.	n.a.	n.a.	n.a.	n.a.	n.a.
27	n.a.	3 x 48		n.a.	n.a.	n.a.	n.a.	n.a.	n.a.	n.a.	n.a.	n.a.
28	n.a.	n.a.	1 x 48	n.a.	n.a.	n.a.	n.a.	n.a.	n.a.	n.a.	n.a.	n.a.
29	n.a.	n.a.	n.a.	n.a.	n.a.	n.a.	n.a.	n.a.	n.a.	n.a.	n.a.	n.a.
31	n.a.	n.a.	n.a.	n.a.	n.a.	n.a.	n.a.	n.a.	n.a.	n.a.	n.a.	n.a.
32	n.a.	n.a.	n.a.	n.a.	n.a.	n.a.	n.a.	n.a.	n.a.	n.a.	n.a.	n.a.
33	n.a.	n.a.	n.a.	n.a.	n.a.	n.a.	n.a.	n.a.	n.a.	n.a.	n.a.	n.a.
35	n.a.	n.a.	n.a.	n.a.	n.a.	n.a.	n.a.	n.a.	n.a.	n.a.	n.a.	n.a.
36	n.a.	n.a.	n.a.	n.a.	n.a.	n.a.	n.a.	n.a.	n.a.	n.a.	n.a.	n.a.
37	n.a.	n.a.	n.a.	n.a.	n.a.	n.a.	n.a.	n.a.	n.a.	n.a.	n.a.	n.a.
39	n.a.	n.a.	n.a.	n.a.	n.a.	n.a.	n.a.	n.a.	n.a.	n.a.	n.a.	n.a.
41	n.a.	n.a.	n.a.	n.a.	n.a.	n.a.	n.a.	n.a.	n.a.	n.a.	n.a.	n.a.
Limit batt min C	16 blocs			20 blocs			24 blocs			28 blocs		
	Cabinet C: max 3 x 48 x 7/9Ah batteries											

Powerscale 40kVA, 36kW												
Autonomy (min)	Load Power											
	18kW			25kW			32kW			36kW		
	7Ah batt	9Ah batt	28Ah batt	7Ah batt	9Ah batt	28Ah batt	7Ah batt	9Ah batt	28Ah batt	7Ah batt	9Ah batt	28Ah batt
6	2 x 36	2 x 22		2 x 48	2 x 32		3 x 48	2 x 48		3 x 48	2 x 48	
7			1 x 18			1 x 26			1 x 32	n.a.	3 x 36	1 x 36
8	2 x 42	2 x 28		3 x 40	2 x 40		n.a.		1 x 34	n.a.		1 x 42
9	2 x 48		1 x 22				n.a.			n.a.	3 x 46	1 x 44
10	3 x 34	2 x 34		3 x 48	2 x 48	1 x 34	n.a.		1 x 40	n.a.	3 x 48	1 x 48
12	3 x 40	2 x 40	1 x 28	n.a.	3 x 38		n.a.	3 x 48	1 x 48	n.a.	n.a.	n.a.
13	3 x 42	2 x 44		n.a.	3 x 40	1 x 40	n.a.	n.a.	n.a.	n.a.	n.a.	n.a.
15	3 x 48	2 x 48	1 x 32	n.a.	3 x 44		n.a.	n.a.	n.a.	n.a.	n.a.	n.a.
16	n.a.	3 x 34		n.a.	3 x 48	1 x 48	n.a.	n.a.	n.a.	n.a.	n.a.	n.a.
18	n.a.	3 x 38		n.a.	n.a.	n.a.	n.a.	n.a.	n.a.	n.a.	n.a.	n.a.
20	n.a.	3 x 40	1 x 40	n.a.	n.a.	n.a.	n.a.	n.a.	n.a.	n.a.	n.a.	n.a.
22	n.a.	3 x 44	1 x 44	n.a.	n.a.	n.a.	n.a.	n.a.	n.a.	n.a.	n.a.	n.a.
24	n.a.		1 x 48	n.a.	n.a.	n.a.	n.a.	n.a.		n.a.	n.a.	
25	n.a.	3 x 48		n.a.	n.a.	n.a.	n.a.	n.a.	n.a.	n.a.	n.a.	n.a.
27	n.a.	n.a.	n.a.	n.a.	n.a.	n.a.	n.a.	n.a.	n.a.	n.a.	n.a.	n.a.
28	n.a.	n.a.	n.a.	n.a.	n.a.	n.a.	n.a.	n.a.	n.a.	n.a.	n.a.	n.a.
29	n.a.	n.a.	n.a.	n.a.	n.a.	n.a.	n.a.	n.a.	n.a.	n.a.	n.a.	n.a.
31	n.a.	n.a.	n.a.	n.a.	n.a.	n.a.	n.a.	n.a.	n.a.	n.a.	n.a.	n.a.
32	n.a.	n.a.	n.a.	n.a.	n.a.	n.a.	n.a.	n.a.	n.a.	n.a.	n.a.	n.a.
33	n.a.	n.a.	n.a.	n.a.	n.a.	n.a.	n.a.	n.a.	n.a.	n.a.	n.a.	n.a.
35	n.a.	n.a.	n.a.	n.a.	n.a.	n.a.	n.a.	n.a.	n.a.	n.a.	n.a.	n.a.
36	n.a.	n.a.	n.a.	n.a.	n.a.	n.a.	n.a.	n.a.	n.a.	n.a.	n.a.	n.a.
37	n.a.	n.a.	n.a.	n.a.	n.a.	n.a.	n.a.	n.a.	n.a.	n.a.	n.a.	n.a.
39	n.a.	n.a.	n.a.	n.a.	n.a.	n.a.	n.a.	n.a.	n.a.	n.a.	n.a.	n.a.
41	n.a.	n.a.	n.a.	n.a.	n.a.	n.a.	n.a.	n.a.	n.a.	n.a.	n.a.	n.a.
Limit batt min C	18 blocs			26 blocs			32 blocs			36 blocs		
	Cabinet C: max 3 x 48 x 7/9Ah batteries											

Powerscale 50kVA, 45kW												
Autonomy (min)	Load Power											
	30kW			35kW			40kW			45kW		
	7Ah batt	9Ah batt	28Ah batt	7Ah batt	9Ah batt	28Ah batt	7Ah batt	9Ah batt	28Ah batt	7Ah batt	9Ah batt	28Ah batt
6	3 x 40	2 x 40	1 x 30	3 x 48	2 x 48	1 x 34	n.a.			n.a.		
7	3 x 44	2 x 44		n.a.			n.a.	3 x 40**	1 x 40	n.a.	3 x 46	1 x 46
8	3 x 48	2 x 48	1 x 34	n.a.	3 x 40	1 x 40	n.a.	3 x 44		n.a.	3 x 48	1 x 48
9	n.a.	3 x 36		n.a.			n.a.	3 x 48	1 x 48	n.a.	n.a.	n.a.
10	n.a.	3 x 40	1 x 40	n.a.	3 x 44	1 x 48	n.a.	n.a.	n.a.	n.a.	n.a.	n.a.
12	n.a.	3 x 44		n.a.	3 x 48		n.a.	n.a.	n.a.	n.a.	n.a.	n.a.
13	n.a.	3 x 48	1 x 48	n.a.	n.a.	n.a.	n.a.	n.a.	n.a.	n.a.	n.a.	n.a.
15	n.a.	n.a.	n.a.	n.a.	n.a.	n.a.	n.a.	n.a.	n.a.	n.a.	n.a.	n.a.
16	n.a.	n.a.	n.a.	n.a.	n.a.	n.a.	n.a.	n.a.	n.a.	n.a.	n.a.	n.a.
18	n.a.	n.a.	n.a.	n.a.	n.a.	n.a.	n.a.	n.a.	n.a.	n.a.	n.a.	n.a.
20	n.a.	n.a.	n.a.	n.a.	n.a.	n.a.	n.a.	n.a.	n.a.	n.a.	n.a.	n.a.
22	n.a.	n.a.	n.a.	n.a.	n.a.	n.a.	n.a.	n.a.	n.a.	n.a.	n.a.	n.a.
24	n.a.	n.a.	n.a.	n.a.	n.a.	n.a.	n.a.	n.a.	n.a.	n.a.	n.a.	n.a.
25	n.a.	n.a.	n.a.	n.a.	n.a.	n.a.	n.a.	n.a.	n.a.	n.a.	n.a.	n.a.
27	n.a.	n.a.	n.a.	n.a.	n.a.	n.a.	n.a.	n.a.	n.a.	n.a.	n.a.	n.a.
28	n.a.	n.a.	n.a.	n.a.	n.a.	n.a.	n.a.	n.a.	n.a.	n.a.	n.a.	n.a.
29	n.a.	n.a.	n.a.	n.a.	n.a.	n.a.	n.a.	n.a.	n.a.	n.a.	n.a.	n.a.
31	n.a.	n.a.	n.a.	n.a.	n.a.	n.a.	n.a.	n.a.	n.a.	n.a.	n.a.	n.a.
32	n.a.	n.a.	n.a.	n.a.	n.a.	n.a.	n.a.	n.a.	n.a.	n.a.	n.a.	n.a.
33	n.a.	n.a.	n.a.	n.a.	n.a.	n.a.	n.a.	n.a.	n.a.	n.a.	n.a.	n.a.
35	n.a.	n.a.	n.a.	n.a.	n.a.	n.a.	n.a.	n.a.	n.a.	n.a.	n.a.	n.a.
36	n.a.	n.a.	n.a.	n.a.	n.a.	n.a.	n.a.	n.a.	n.a.	n.a.	n.a.	n.a.
37	n.a.	n.a.	n.a.	n.a.	n.a.	n.a.	n.a.	n.a.	n.a.	n.a.	n.a.	n.a.
39	n.a.	n.a.	n.a.	n.a.	n.a.	n.a.	n.a.	n.a.	n.a.	n.a.	n.a.	n.a.
41	n.a.	n.a.	n.a.	n.a.	n.a.	n.a.	n.a.	n.a.	n.a.	n.a.	n.a.	n.a.
Limit batt min C	30 blocs			34 blocs			40 blocs			46 blocs		
	Cabinet C: max 3 x 48 x 7/9Ah batteries											
	** The Nr of battery blocs is limited to 40 at 40kW											

10.11 INSTALLATION PLANNING

Clearances	X	Y
Minimum	200 mm	900 mm

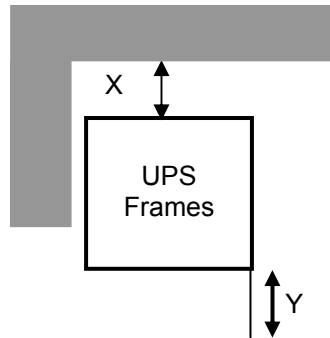

Figure 1: UPS space recommendation

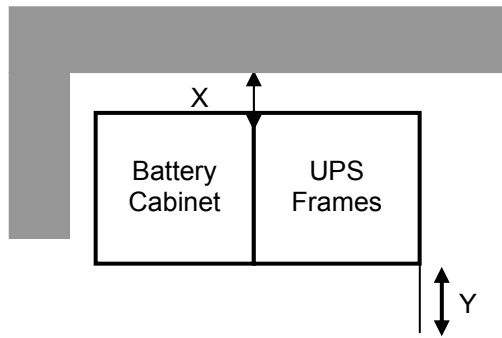

Figure 2 : UPS + Battery space recommendation

UPS Frame type	Cabinet A	Cabinet B	Cabinet C	CBATT-C
Dimensions (WxHxD) mm	345x720x710	345x1045x710	440x1400x910	480x1400x940
Accessibility	Top / Rear / Right+Left side: Cabinet A & B Top / Front / Right+Left: Cabinet C			
Positioning	Min. 200 mm rear space (required for fan)			
Input and Output Power Cabling	From the bottom on the rear side			

10.11.1 HEAT DISSIPATION PER UPS RANGE WITH NON-LINEAR LOAD

UPS Range		10kVA	15kVA	20kVA	25kVA	30kVA	40kVA	50kVA
Heat Dissipation with 100% Non-linear Load per range (EN 62040-3)	W	600	900	1100	1400	1700	2300	2900
Heat Dissipation with 100% Non-linear Load per range (EN 62040-3)	BTU/h	2048	3072	3754	4778	5802	7850	9898
Airflow (25° - 30°C) with 100% Non-linear Load per range (EN 62040-3)	m ³ /h	150	150	150	150	570	570	570
Heat Dissipation without load	W	120	150	150	170	250	300	350

10.12 WIRING AND BLOCK DIAGRAMS FOR ALL UPS FRAMES

The customer has to supply the wiring to connect the UPS to the local power source. The installation inspection and initial start up of the UPS and extra battery cabinet must be carried out by a qualified service personnel such as a licensed service engineer from the manufacturer or from an agent authorised by the manufacturer. More details and procedure are mentioned in the user manual.

10.12.1 TERMINAL CONNECTIONS OVERVIEW

UPS Range Terminals (T) Connection Bar (B)	Battery (+ / N / -) +PE	Input Bypass 3+N (N,2L1,2L2,2L3)	Input Rectifier 3+N+PE (N,1L1,1L2,1L3)	Output load 3+N+PE (N,3L1,3L2,3L3)	Max. cable section admissible	Toghtening Torque
10kVA (Fig.1)	4 x 16 mm ²	4 x 16 mm ²	5 x 16 mm ²	5 x 16 mm ²	16 mm ²	1.5 (Nm)
15kVA (Fig.1)	4 x 16 mm ²	4 x 16 mm ²	5 x 16 mm ²	5 x 16 mm ²	16 mm ²	1.5 (Nm)
20kVA (Fig.1)	4 x 16 mm ²	4 x 16 mm ²	5 x 16 mm ²	5 x 16 mm ²	16 mm ²	1.5 (Nm)
25kVA (Fig.1)	4 x 16 mm ²	4 x 16 mm ²	5 x 16 mm ²	5 x 16 mm ²	16 mm ²	1.5 (Nm)
30kVA (Fig.2)	4 x 35 mm ²	4 x 35 mm ²	5 x 35 mm ²	5 x 35 mm ²	35 mm ²	3.5 (Nm)
40kVA (Fig.2)	4 x 35 mm ²	4 x 35 mm ²	5 x 35 mm ²	5 x 35 mm ²	35 mm ²	3.5 (Nm)
50kVA (Fig.2)	4 x 35 mm ²	4 x 35 mm ²	5 x 35 mm ²	5 x 35 mm ²	35 mm ²	3.5 (Nm)

Fig. 1: 10-25 kVA cabinet A/B

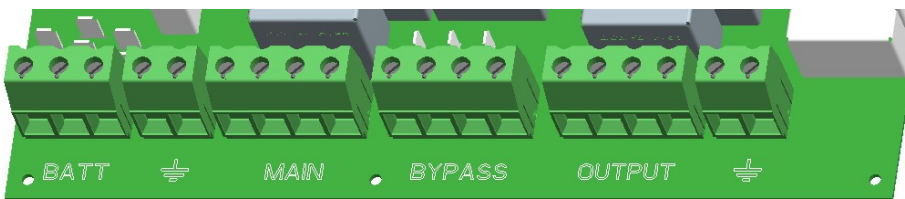
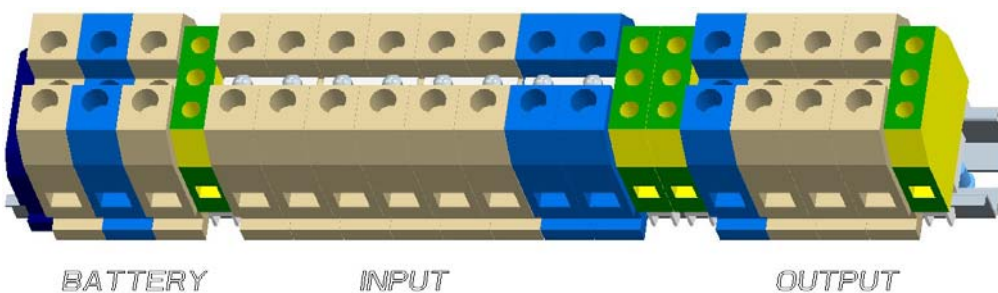

Fig. 2: 30-50 kVA cabinet C



10.12.2 INPUT FEED RATINGS

Cable Sections and Fuse Ratings recommended. Alternatively, local standards to be respected

Block Diagram

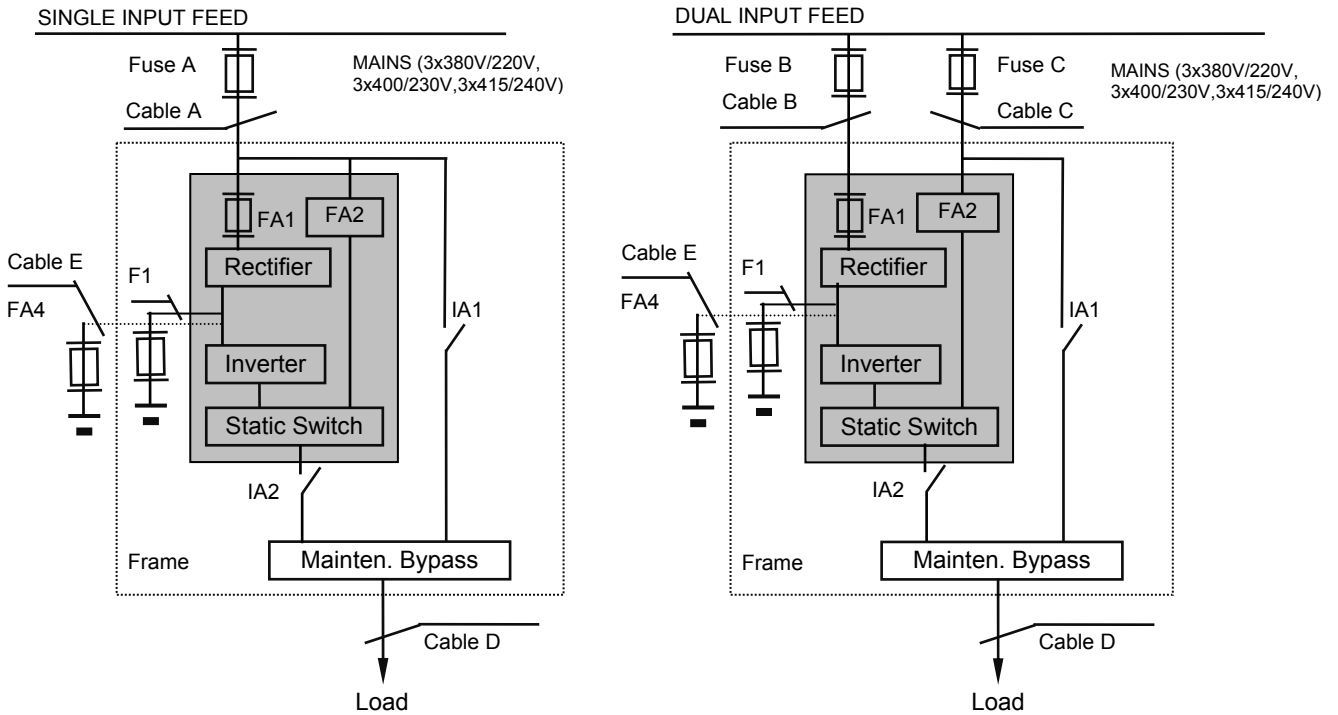

Figure 3.3: Block Diagram POWERSCALE from 10-50 kVA

STANDARD VERSION (SINGLE INPUT FEED)

Power (kVA)	Fuse A (Agl/CB)	Cable A (IEC 60950-1:2001)	Cable D (IEC 60950-1:2001)	Fuse E +/-	Cable E +/-
10	3x20	5x2.5	5x2.5	3x32A	3x4 + PE
15	3x32	5x4	5x4	3x32A	3x4 + PE
20	3x40	5x6	5x6	3x50A	3x10 + PE
25	3x40	5x6	5x6	3x50A	3x10 + PE
30	3x63	5x10	5x10	3x80A	3x16 + PE
40	3x80	5x25	5x25	3x100A	3x25 + PE
50	3x80	5x25	5x25	3x10A	3x25 + PE

VERSION ON REQUEST (DUAL INPUT FEED)

Power (kVA)	Fuse B (Agl/CB)	Cable B (IEC 60950-1:2001)	Fuse C (Agl/CB)	Cable C (IEC 60950-1:2001)	Cable D (IEC 60950-1:2001)	Fuse E +/-	Cable E +/-
10	3x20	5x2.5	3x20	4x2.5	5x2.5	3x32A	3x4 + PE
15	3x32	5x4	3x32	4x4	5x4	3x32A	3x4 + PE
20	3x40	5x6	3x40	4x6	5x6	3x50A	3x10 + PE
25	3x40	5x6	3x40	4x6	5x6	3x50A	3x10 + PE
30	3x63	5x10	3x63	4x10	5x10	3x80A	3x16 + PE
40	3x80	5x25	3x80	4x25	5x25	3x100A	3x25 + PE
50	3x80	5x25	3x80	4x25	5x25	3x10A	3x25 + PE

DUAL INPUT FEED IS AVAILABLE ON REQUEST